

KARL FISCHER REAGENTS

TECHNICAL MANUAL



 KARL FISCHER REAGENTS TECHNICAL MANUAL  MITSUBISHI CHEMICAL CORPORATION



Introduction

The methods used to analyze moisture content in substances range from the loss-on-drying method to physical, electrical and optical systems.

Moisture content measurement by means of Karl Fischer reagents is now widely employed as the only reliable chemical method.

Today the method is widely accepted as a moisture content measurement system for both chemicals and manufactured products. It has been adopted as an international standard by the International Standards Organization (ISO), as an American Standard Testing Method (ASTM) in the United States, and is also included in the German DIN standards and the British BS system. The method has also been incorporated into Japanese standards, including the Japanese Industrial Standards (JIS) and Japanese Agricultural Standards (JAS). It is also included in Japanese pharmaceutical practice, the official food additive manual, and the Japan Petroleum Institute Standards.

Development of Karl Fischer Reagents

The German scientist Karl Fischer (1901-1958) first revealed his new reagent to the world in a paper [NOTE 1] published in 1935. A mixture of iodine, sulfur dioxide, pyridine and methanol, it was named after its inventor. As shown in the following formula, Karl Fischer reagents react selectively to water in specific amounts. Mitchell & Smith subsequently carried out a detailed study of the reaction [NOTE 2] and published findings that indicated a reaction of 1 mole of iodine to 1 mole of water. This basic reaction formula remains in use today.

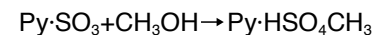
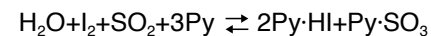

In recent years, however, the Karl Fischer reaction mechanism has been studied on a more theoretical level. A published paper [NOTE 3] shows that the pyridine acts simply as a buffer and that it is not essential to the reaction. The following reaction formula, in which pyridine is expressed as a base, has been put forward.

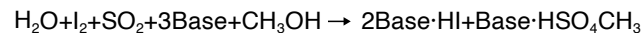

Note: Base = Amin. "Base" is sometimes shown as RN.

Characteristics of the Karl Fischer Titration Method

The measurement of moisture content using Karl Fischer reagents is superior to other methods such as loss-on-drying, distillation and infrared absorption, or to electrolysis and other electrical methods, for the following reasons:

- (1) The absolute amount of moisture can be determined without a working curve (in the case of coulometric titration). Moisture content can be determined accurately, even where moisture is present at levels of only a few ppm.
- (2) Measurements can be taken over short periods of time.
- (3) Measurements can be taken using small samples (from a few mg to a few gm).
- (4) The method can be used with liquid, solid and gaseous samples.
- (5) The method is suitable for unstable substances that can alter when heated.

Mitsubishi Chemical Corporation and Karl Fischer Reagents

Mitsubishi Chemical Corporation recognized early on the advantages of the Karl Fischer reagent, when it was introduced into Japan in the postwar era. The company began to investigate this in 1950. It subsequently developed Karl Fischer reagent SS, a single solution with stable titer that could be used by anyone in factory research or analytical laboratories. It also developed and supplied a variety of dehydrating solvents for use with various types of samples. In addition, Mitsubishi Chemical Corporation developed simple methods for measuring the moisture content of various substances and manufactured products. With each new methodology, the company endeavored to promote the use of the Karl Fischer titration method through papers for scientific symposiums and society journals (about 60 to date).

In 1985, Mitsubishi Chemical Corporation developed a new Karl Fischer reagent without the pyridine odor. The new pyridine-free products were named the "S-Series". The company continues to respond to the needs of its customers. In 1992, it added the X-Series products, which do not contain carbon tetrachloride or chloroform, to its range of coulometric reagents.

This manual has been written to provide basic information on Karl Fischer

reagents and analytical methods. As we want this manual to have immediate application, we have used the Q&A approach to make it easy to find needed information. We hope that this manual will become a useful reference guide and one that will serve to build and improve knowledge of our range of Karl Fischer reagent products.

- (1) Fischer, K.; *Angew. Chem.*, 48,394 (1935).
- (2) Smith, D.M., Bryant. W.M.D., Mitschell; J.; *J. Am. Chem. Soc.*, 61,2407 (1939).
- (3) Verhoef, J.C.; *J. Electroanal. Chem.*, 71,305 (1976), 75,705 (1977).

March 2004

CONTENTS

Chapter I: Basic Knowledge

I-1 Questions & Answers about Karl Fischer Reagents	11
1. Karl Fischer Titration	11
Q1 : What are the other methods currently available for the measurement of moisture content? Please explain how these differ from Karl Fischer titration?	11
Q2 : Please explain briefly how moisture content is measured using Karl Fischer reagents?	11
Q3 : Could you outline the principle and procedures involved in volumetric titration?	14
Q4 : Please outline the principles and procedures involved in coulometric titration.	16
Q5 : What is the moisture vaporization method, and when is it used?	19
2. Karl Fischer Reagent Products	22
Q6 : What volumetric titration reagents are available? Please explain the types of reagents and their uses, and the methods employed.	22
Q7 : What coulometric titration reagents are there? Please explain the types of reagents and their uses, and the methods employed.	33
3. Applicability of Karl Fischer Titration	37
Q8 : What substances is Karl Fischer titration suitable for?	37
Q9 : What is interference in the context of the Karl Fischer titration? Please explain what is meant by interference reactions.	39
Q10 : Please outline any methods that can be used to suppress interference reactions so that Karl Fischer titration can be employed.	43
4. Procedures for Karl Fischer Titration	45
Q11 : How should we actually carry out volumetric titration? Please describe the preparations and procedures involved.	45
Q12 : How can we actually measure moisture content using coulometric titration? Please describe the preparations and procedures involved.	51
Q13 : Sampling procedures are one of the most important aspects of moisture content measurement. What are the specific methods and equipment involved?	54

5. Official Testing Methods and Documentation.....	59
Q14 : Karl Fischer titration is classed as an official testing method. What Japanese standards have been adopted?	59
Q15 : Please provide some example of the international standards(ISO) and foreign standards that have been adopted for the Karl Fischer titration method.	69
Q16 : What reference works are there concerning Karl Fischer measurement methods?.....	71
6. Important Information about Handling and Using Karl Fischer Reagents.....	73
Q17 : Are there any safety requirements or other precautions that should be followed when using Karl Fischer reagents?	73
Chapter II: Applications Part 1	75
II-1 Organic Compounds	77
1. Hydrocarbons.....	78
2. Halogenated Hydrocarbons.....	80
3. Alcohols	82
4. Ethers	84
5. Phenols	86
6. Ketones	86
7. Aldehydes.....	91
8. Organic Acids.....	95
9. Esters	97
10. Organic Acid Salts	99
11. Organic Hydrates	100
12. Amines	102
13. Amides, Anilides	106
14. Nitriles, Cyanohydrins.....	107
15. Hydrazines	108
16. Other Nitrogenous Compounds.....	109
17. Acid Anhydrides	111
18. Acid Chlorides.....	111
19. Quinones	112
20. Peroxides	113
21. Sulfur Compounds	114

II-2 Inorganic Compounds.....	118
1. Metals and Simple Substances	119
2. Inorganic Acids	121
3. Hydroxides	124
4. Oxides	125
5. Halides(halogenides).....	127
6. Carbonates, Bicarbonates	129
7. Sulfates, Sulfites.....	131
8. Other Salts	133
9. Inorganic Gases.....	135
Chapter III: Applications-2	136
III-1 Industrial Products.....	139
1. Fertilizers.....	139
2. Agricultural Chemicals.....	141
3. Glass/Ceramics.....	142
4. Liquefied Petroleum Gases	144
5. Coals, Tars	147
6. Petroleum Products	149
7. Plastics	153
8. Rubber, Rubber Products, Compounding Agents	156
9. Fibers, Papers.....	158
10. Dyestuff Intermediates.....	159
11. Pigments.....	161
12. Paints.....	162
13. Printing Inks and Imaging Materials	164
14. Adhesives.....	165
15. Soaps and Detergents	167
16. Cosmetics	169
17. Chemicals & Materials for Electronic Equipment and Electrical Parts	171
III-2 Foodstuffs.....	173
1. Food Additives and Flavorings	173
2. Cereals and Dried Vegetables.....	177
3. Sugars and Condiments	179
4. Confectionery.....	180
5. Dairy Products, Fat Products	182

6. Goument Foods, etc.	184
III-3. Pharmaceuticals.....	186
1. Biochemical Products.....	186
2. Pharmaceuticals.....	188
3. Chinese Herbal Medicines, Biological Tissue, etc.....	190
III-4. Minerals and Natural Products.....	192
1. Minerals.....	192
2. Natural Products.....	195
Chapter IV List of Karl Fischer Reagents.....	197
Chapter V Summary of Selection Procedures for Karl Fischer Reagents.....	206
Chapter VI Index.....	209

Chapter I: Basic Knowledge

Chapter I: Basic Knowledge

I-1. Questions & Answers about Karl Fischer Reagents

1. Karl Fischer Titration

Q1 | What are the other methods currently available for the measurement of moisture content? Please explain how these differ from Karl Fischer titration?

There are many ways of measuring moisture content. Methods based on new principles are still being announced. The following table lists the primary methods in current use. Karl Fischer titration is regarded as the most useful of these methods by virtue of its wide applicability and its capacity to measure absolute values. It is the focus of continuing research.

Measurement method	Measuring range	Applications	Interfering substances
Karl Fischer titration	A few ppm - 100%	gases, liquids, solids	Oxidizing, reducing substances
Drying	0.01%	solids	Volatile substances, unstable substances
Azeotropic distillation	0.05%	liquids	Volatile water-soluble substances
Colorimetric method	0.1-a few %	solids, liquids	Colored substances
Infrared absorption	0.01-a few %	gases, liquids, solids	Alcohol, amine, etc.
Gas chromatography	ppm-a few %	gases, liquids	Substances with the same retention capacity
Dew point method	ppm-a few %	gases	Condensable substances
Electrolysis	1-1000ppm	gases	ROH, RCHO, NH ₃ , HF
Electric resistance (Conductimetric method)	0.3%-a few %	gases, liquids	Conductive substances
Dielectric constant method	1-a few %	gases, liquids	Substances with high dielectric ratios
Neutron scattering method	a few %	solids	Substances containing hydrogen
Quartz oscillation method	1-1000ppm	gases	Substances that react with sensing membranes

Q2 | Please explain briefly how moisture content is measured using Karl Fischer reagents?

1. Methods

There are two methods based on the use of Karl Fischer reagents, or Karl Fischer titration, to measure moisture content.

- (1) Volumetric titration
- (2) Coulometric titration

Your choice should reflect a proper understanding of each method. It is also essential to use the appropriate reagent in each case. The following table compares the characteristics of each method.

Item	Volumetric titration	Coulometric titration
Principle	A method of volumetric analysis used to determine moisture content from the titrated amount of Karl Fischer reagent	Iodine produced through electrolytic oxidation undergoes a KF reaction with water. Moisture content is determined by measuring the amount of electricity required to the point where excess iodine is produced.
Titration reagents	Karl Fischer reagent and titration solvent (dehydrated solvent)	Anolyte and catholyte
Characteristics	<ol style="list-style-type: none"> 1) Since a Karl Fischer reagent is used as the titration agent, the titer must be known in advance. 2) A wide range of reagents can be used as various dehydrating agents are available. 3) The method can be used to measure moisture content across a wide range. However, it is not suitable at the microgram level. 	<ol style="list-style-type: none"> 1) The factors measured are current and time. Since electrons act as the titration agent, a standard solution is not required. The method allows measurement of absolute quantities based on the Faraday constant. 2) The same anolyte can be used repeatedly. 3) The method is effective for measuring minute amounts of water. Electricity can be measured in tiny increments, so it is possible to measure water in quantities of a μg

2. Titration Equipment

With Karl Fischer titration, electrical detection methods are used to determine the end point. It is important to use the following types of titration equipment.

Volumetric titration : Automatic volumetric moisture meter
 Coulometric titration : Automatic coulometric moisture meter
 There are now convenient automatic moisture measurement systems designed for ease of operation.

As Karl Fischer reagents are affected by atmospheric moisture, an airtight titration cell must be used.

For your information

1. Unlike standard volumetric analysis, it is not possible with Karl Fischer titration simply to fill a buret with Karl Fischer reagent and add it one drop

at a time to a flask or beaker that is exposed to the air. Since Karl Fischer instantly reacts with atmospheric moisture, the end-point would never be reached.

2. At present there is no method that allows the color change at the endpoint of Karl Fischer titration to be detected visually. The only method is to detect minute amounts of surplus iodine electrically.

! Helpful hint -1

How is the end-point detected electrically?

The volumetric and coulometric titration systems currently on the market employ controlled current voltage detection (constant-current polarization voltage detection). A constant current of 1-30 μA is applied to two platinum electrodes, and the end-point is detected by measuring the voltage (polarization voltage) between the electrodes. If the titration solution has a relatively high water content, a polarization voltage of 300-500 mV will be produced. The voltage varies according to the type of solvent used and the sample. In general, high voltages are produced in the case of substances with low conductivity, such as hydrocarbons.

As the Karl Fischer titration continues and the end-point approaches, the voltage will suddenly drop to 10-50 mV. With volumetric analysis, the endpoint is deemed to have been reached after the voltage has remained at this level for a specific period of time. With commercially available titration systems, the period is 30-60 seconds. With coulometric analysis, an endpoint voltage is specified, and the end-point is reached when the voltage falls below that level.

Q3 | Could you outline the principle and procedures involved in volumetric titration?

[Principle]

Karl Fischer titration is a volumetric analysis method that takes advantage of the fact that iodine contained in Karl Fischer reagents reacts quantitatively and selectively with water, as shown in the following formula.

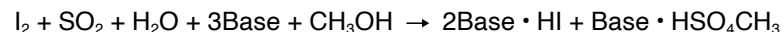

The quantification is based on the stoichiometrical principle that 1 mole of iodine (254g) reacts with 1 mole of water (18g). In practice, the titer of a Karl Fischer reagent is expressed as a water equivalent. Unlike normal volumetric analysis methods, the concentration of iodine is not shown. For example, Mitsubishi Chemical's SS-X Karl Fischer reagent is adjusted so that 1ml will react with approximately 3mg of water, which means that the solution contains approximately 42mg of iodine and has a 3mg titer. Once the water equivalent of a Karl Fischer reagent is known, it is possible to determine moisture content from the amount used (titrated).

Memo "Titer"

This value is used to determine the quantity of a substance from the amount of reagent titrated. It shows the equivalent amount of water per unit of volume and is usually expressed as mg/ml.

[Procedures]

- A dehydrated solvent suitable for the sample is placed in a flask attached to an automatic volumetric moisture meter (Figure 1).
- The Karl Fischer reagent is titrated until all water has been eliminated from the titration flask. (It is not necessary at this time to read the amount titrated.) The titer of the Karl Fischer reagent is determined using water, etc.
- The sample is added.
- The Karl Fischer reagent, the titer of which (mg/ml) has now been determined, is titrated until the end-point is reached. The end-point is detected electrically by means of a detection circuit built into the titration system.
- Moisture content is determined from the amount titrated according to the

following formula:

$$\text{Moisture content(\%)} = \frac{\text{Titration quantity (ml)} \times \text{titer (mg/ml)}}{\text{Sample quantity (g)} \times 1000} \times 100$$

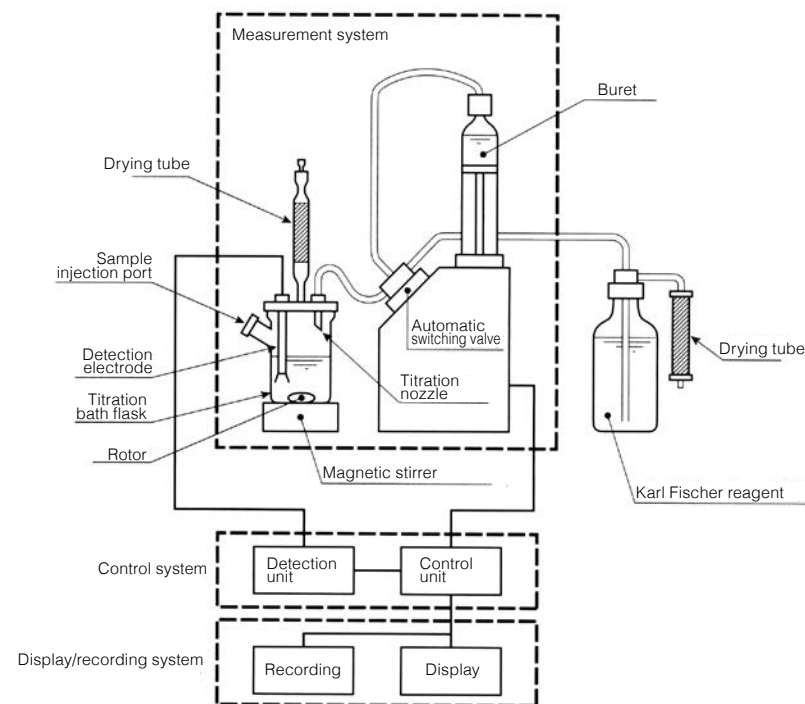
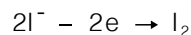

Figure 1: Automatic Volumetric Moisture Titration System

Q4 Please outline the principles and procedures involved in coulometric titration.

[Principle]

With coulometric titration, electrolytic oxidation is achieved by adding the sample to an iodide ion solution, instead of the iodine contained in the Karl Fischer reagent and used as the titration agent for volumetric titration. As shown in the following formula, electrolytic oxidation produces iodine at the anode. The electrolytic solution immediately begins to act as a Karl Fischer reagent and reacts with the water in the sample. At the end of the process, the excess iodine can be detected electrically.



According to Faraday's laws, the iodine is produced in proportion to the quantity of electricity. This means that the water content can immediately be determined from the Coulombs required for electrolysis. To produce 1 mole of iodine requires 96485×2 Coulomb {current (amperes) \times time (seconds)}. Since 1 mole of iodine reacts with 1 mole of water, the amount of electricity required to cause a reaction with 1mg of water will be as follows.

$$96485 \times 2 / 18020 = 10.71 \text{ Coulombs}$$

This means that if electrolysis takes 1 second with a current of 107mA, the amount of water can be quantified as 10ug. Normally, titration systems sold over the counter carry out electrolysis at 300-400mA. This design allows titration at the rate of about 30ug per second.

Memo " Faraday's Laws"

The laws relate to electrolysis.

(1) The mass of an electrolyzed substance deposited on an electrode is proportionate to the amount of electricity.

(2) The quantity of a substance deposited by a given amount of electricity is proportionate to its chemical equivalent weight.

Faraday constant = 96485 C/mol

[Procedures]

- Electrolyte solutions (Aquamicron AX and CXU) are introduced into the anode and cathode chambers of an electrolysis cell (Figure 3) attached to an automatic coulometric moisture meter (Figure 2).
- An electrolytic current is passed through the anolyte as it is stirred in the anode chamber. All water is removed from the electrolysis cell by producing iodine until the end-point is reached. (It is not necessary at this time to read the amount titrated.)
- The sample is then introduced, and the electrolysis process is started again. Coulometric titration is continued until the end-point is reached. The end-point is detected electrically by means of a detection circuit built into the titration system.
- Moisture content is automatically calculated from the amount of electricity required for electrolysis in the automatic coulometric moisture meter. The amount of water is expressed in ug units.

$$\text{Moisture content (ppm)} = \frac{\text{Measured value } (\mu\text{g})}{\text{Quantity of sample (g)}}$$

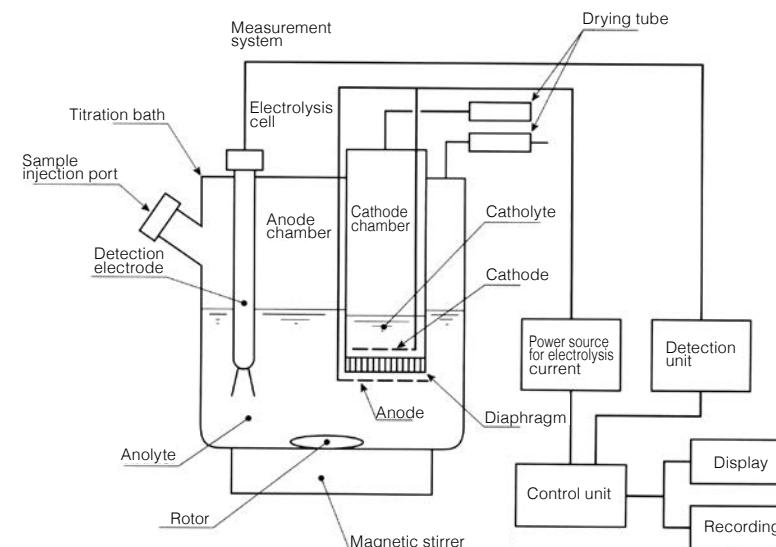

Figure 2: Automatic Coulometric Moisture Meter

- (1) Anode chamber
- (2) Cathode chamber
- (3) Anode
- (4) Cathode
- (5) Diaphragm
- (6) Rotor
- (7) Drying tube for anode chamber
- (8) Drying tube for cathode chamber
- (9) Stopper
- (10) Sample injection port
- (11) Drain cock
- (12) Detection electrode

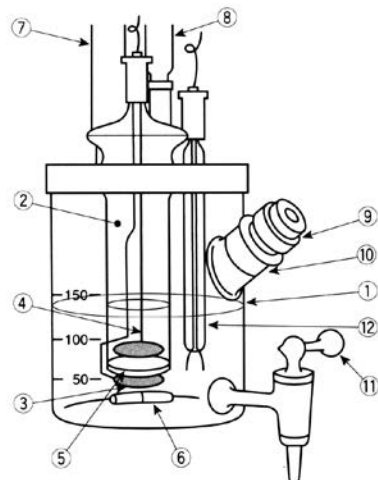

Figure 3: Electrolysis Cell

! Helpful hint - 2

Are there any criteria to guide the choice between volumetric and coulometric titration?

The following factors should be taken into account when making this decision.

(1) Using the characteristics of coulometric titration

The need to check titer is eliminated, since it is not necessary to standardize the Karl Fischer reagent. This feature is very useful for reducing the work involved in everyday analysis tasks.

(2) Moisture content as a criterion

Coulometric titration should be used if the moisture content is 1% or lower. It is especially useful for measuring moisture content at the ppm level within tolerances of a few ppm.

Coulometric titration can still be used if the moisture content is higher than about 1%, but it is necessary to use small samples, and analysis results will be influenced by weighing error. Normally volumetric titration is used in such cases.

(3) Electrode reactions

Coulometric titration is not used for substances that react with

electrodes, such as anilines, diamines and some phenols. Volumetric titration is carried out using a suitable dehydrated solvent.

(4) Solids that do not dissolve in electrolyte

Solids that do not dissolve in organic solvents can reduce current efficiency by obstructing electrodes and diaphragms. In principle, coulometric titration should be avoided in such cases. Use volumetric titration with a suitable dehydrated solvent, or the moisture vaporization method.

.....

Q5 | What is the moisture vaporization method, and when is it used?

[Outline]

The moisture vaporization method is used to measure samples of solids that cannot be dissolved in dehydrated solvents or electrolytes, or samples that include interfering substances. The moisture content is vaporized by heating the sample in a flow of dried nitrogen gas. It is then captured in a dehydrated solvent or electrolyte and subjected to Karl Fischer titration.

Either coulometric or volumetric titration is used.

This method is commonly used with natural substances, such as minerals and rocks, and with macromolecules such as polymers and rubber. New areas of use include electronic materials, including printed circuit boards and wafers, and printing materials, such as toners. This method is also useful for petroleum products containing additives, such as lubricants.

Convenient moisture vaporization systems are available commercially to suit various purposes. They can be connected to either volumetric or coulometric titration systems and used to measure moisture content.

[Procedures]**a) Solid samples**

i) Nitrogen gas (or air) is first passed through a drying tube (filled with silica gel or phosphorus pentoxide, etc.) and then supplied at a rate of approximately 200ml/min. to an oven that is maintained at a suitable temperature for vaporization.

ii) The sample boat is placed in the heating tube and exposed to the flow of nitrogen gas to ensure that the heating system is free of moisture.

iii) The sample is immediately placed in the sample boat and inserted into an oven that is maintained at the required temperature.

iv) The vaporized moisture is absorbed into a dehydrated solvent in a titration flask (or into an electrolyte in an electrolysis cell).

v) The absorbed water is subjected to Karl Fischer titration.

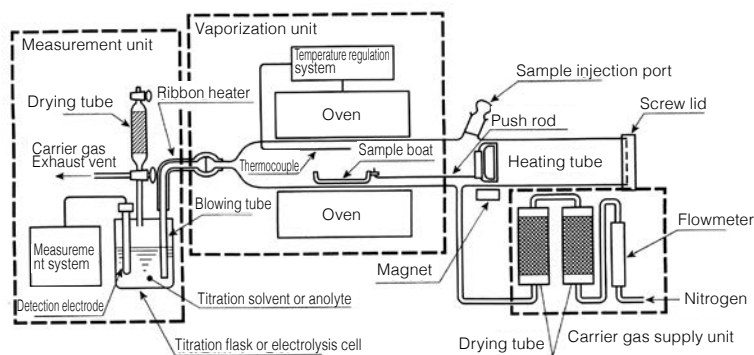

Figure 4: A Moisture Vaporization System (for Solid Samples)

b) Liquid samples, such as lubricating oils

i) Approximately 20ml of a base oil (mineral oil, vacuum pump oil, etc.) is placed in the heating unit of a moisture vaporization system and heated to 100-150°C.

ii) The moisture content of the base oil is totally removed by introducing a flow of dried nitrogen gas into the moisture vaporization system at the rate of approximately 200ml/min.

iii) 1-10g of the sample is added to the base oil, which is now free of moisture.

iv) The vaporized moisture is absorbed into a dehydrated solvent in a titration flask (or into an electrolyte in an electrolysis cell).

v) The absorbed water is subjected to Karl Fischer titration.

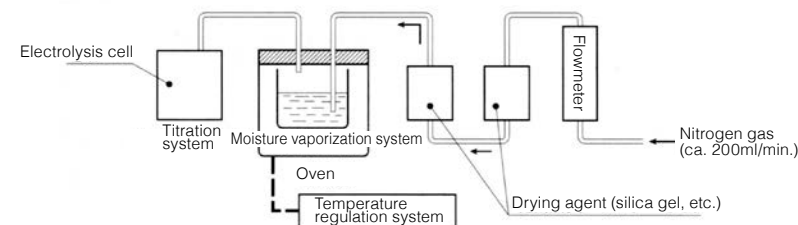

Figure 5: A Moisture Vaporization System (for Lubricating Oils)

! Helpful hint - 3

How can we check for accuracy when a moisture vaporization apparatus is added to the system?

The accuracy of capture is an important concern, since moisture vaporized in the moisture vaporization apparatus is carried through the heating tube and blowing tube by means of dried nitrogen gas before being absorbed into a dehydrated solvent (or into an electrolyte in an electrolysis cell). The capture ratio (recovery ratio) can be checked using the following three methods.

(1) Using water

With the water method, which is usually the simplest, 5 or 10ul (5 or 10mg) of water is placed directly into the sample boat using a microsyringe (capacity: 10ul).

(2) Sodium tartrate dihydrate method (theoretical moisture content: 15.66%)

When using this method, the sodium tartrate dihydrate must first be dried at 105°C.

(3) Glass capillary pipette method

The glass capillary pipette method is simple and is suitable for checking amounts in the order of 1,000ug. Glass capillary pipettes are commonly used in biotechnology fields, and their capacities are extremely precise. They provide an easy way to obtain a required volume of water by means of the capillary phenomenon.

Reference: Bunseki, p587, 1995

2. Karl Fischer Reagent Products

Q6 | What volumetric titration reagents are available? Please explain the types of reagents and their uses, and the methods employed.

Mitsubishi Chemical Corporation has a range of products to suit every purpose. Its products can be broadly divided into the following four categories.

- Mitsubishi Karl Fischer Reagents

- Titrant

- Can be used in various titer according to anticipated moisture content

- Mitsubishi Dehydrated Solvents

- They are suitable as titration solvents for the Karl Fischer reaction, to dissolve or disperse a sample in order to extract water.

- Mitsubishi Standard Water Methanol

- This is used to determine the titer of a Karl Fischer reagent. Water methanol can also be used a titration agent for back titration.

- Mitsubishi Standard Liquid

- This is used to determine the titer of a Karl Fischer reagent.

Karl Fischer reagents and dehydrated solvents have traditionally been available in both pyridine types and pyridine-free types, which do not have the pyridine odor. There is no significant difference in performance between the two types, and they can be used interchangeably.

1. Karl Fischer Reagent SS-Z, SS

Initially the titer of Karl Fischer reagents was unstable, and it was necessary to use them in the extremely inconvenient form of binary solutions.

Mitsubishi Chemical was the first manufacturer in the world to perfect a single solution version, which it called "Karl Fischer Reagent SS". Over 50 years that time, Mitsubishi Chemical has continued to enhance and expand its technology, and today enjoys an excellent reputation for its superior products.

Mitsubishi Chemical has also developed Karl Fischer Reagent SS-Z, which is pyridine-free and does not contain chloroform or methyl cellosolve. Users can choose from an extensive product range, as listed below.

Product	Purpose	Titer	Applications	Packaging
SS 10mg	Samples with high moisture content (40% or higher)	8-12 mg / ml	Foodstuffs, Cosmetics Detergents, etc	500ml bottles
SS-Z 5mg	General normal samples	4.5-5.5 mg / ml	General samples, Organic solvents	500ml, 1L bottles
SS-Z 3mg	General normal samples	2.5-3.5 mg / ml	General samples, Organic solvents	500ml, 1L bottles
SS 3mg	General normal samples	2.5-3.5 mg / ml	General samples, Organic solvents	500ml bottles
SS-Z 1mg SS 1mg	Samples with low moisture content (0.1% or lower)	0.7-1.2 mg / ml	Organic solvents, Petroleum products, Gas products	500ml bottles

Karl Fischer Reagent SS-Z: Pyridine-Free and Methyl Cellosolve-Free Types

Instead of pyridine, Karl Fischer SS-Z contains a solid amine. As a result, the product is free of the pyridine odor. All the ingredients required to implement Karl Fischer reactions stoichiometrically are included in a single solution. The product is available in either 5mg/ml, 3mg/ml or 1mg/ml titer.

[Characteristics]

- a) The titer is stable. Even when stored properly under air-tight conditions, Karl Fischer reagents tend to lose titer due to self-reaction. With SS-Z, the titer remains extremely stable and changes at less than 0.05% per day even when stored at room temperature.
- b) SS-Z is suitable even for moisture titration of ketones, which have an interfering effect. SS-Z does not contain methanol, which reacts with ketones. The moisture content of ketones can be measured easily by using SS-Z in combination with the Dehydrated Solvent KTX. (For aldehydes, use SS in combination with CP or PP Dehydrated Solvent).
- c) SS-Z Karl Fischer reagent is available in three titers to suit samples with different moisture contents. The 3mg/ml product is generally regarded as a standard type and should be used first.

Karl Fischer Reagent SS: Pyridine Type

Karl Fischer Reagent SS is the traditional product containing pyridine. Its performance is similar to that of Karl Fischer Reagent SS-Z. It is available in a titer of 10mg/ml, making it suitable for samples with a high moisture content.

For Your Information

Mitsubishi Chemical's series of Karl Fischer reagents are supplied in brown glass bottles sealed with lids containing packing. Provided that the bottles are sealed, they can be stored for long periods with only a minimal decline in titer due to moisture absorption. Once the seal is broken, however, moisture absorption could cause titer to decline unless storage conditions are optimal. Care should be taken to close caps tightly.

 Helpful hint - 4

What is the difference between traditional pyridine products and nonpyridine products?

Pyridine-free types use another amine in place of pyridine as the base.

Pyridine requires special handling because of its strange odor. Pyridine-free products use a liquid or solid amine with a high boiling point in place of pyridine.

Apart from the base, the composition of pyridine-free types is virtually the same as traditional products, and safety requirements are identical.

Furthermore, it has been confirmed that the performance of pyridine-free types is not significantly different from that of traditional types.

The speed of the Karl Fischer reaction varies according to the pH of the titration liquid, the concentration of sulfur dioxide, the type of organic solvent used, the amount of sample added, and changes in the matrix. It is not possible to generalize about the relative speeds of traditional and pyridine-free products, which should be considered on a case-by-case basis.

2. Mitsubishi Dehydrated Solvents

Moisture content measurement using Karl Fischer Reagent SS or SS-X involves the extraction of moisture from a liquid, solid or gaseous sample into a dehydrated solvent from which all moisture has been removed, followed by titration. Ideally, titration solvents should have low moisture content and contain no impurities. However, it is extremely troublesome and time-consuming to refine solvents through distillation and dry them before each use. Mitsubishi Chemical has solved this problem by developing a range of dehydrated solvents so that a solvent suitable for each type of sample will always be available.

In terms of applications, dehydrated solvents can be broadly categorized into those used to dissolve samples and those used to prevent interference reactions. These are shown in the following table. Users should select a solvent that is suitable for the samples.

(1) Mitsubishi Dehydrated Solvents for Use in Dissolving Specimens

A commonly used titration solvent is methanol, which has a large polarity and considerable capacity to extract water. However, a titration solvent to which other solvents have been added is desirable for substances that do not readily dissolve in methanol. Mitsubishi Chemical offers a range of blended solvents to suit user requirements. Please choose the type that is suitable for the characteristics of the sample. With some exceptions, most of the products are blended at 0.2mg/ml or lower.

Principal ingredients	Name	Use	Packaging
Methanol	GEX (pyridine-free) MS ML	General samples	500ml bottles
Methanol Chloroform	OL II (pyridine-free) CM	Petroleum products Oils and fats	500ml bottles
Methanol Formamide	SU (pyridine-free) FM	Sugars, proteins Food additives	500ml bottles
Methanol Ethylene glycol	ME	Gases Inorganic salts	500ml bottles

Dehydrated Solvents GEX and MS

The solvent most commonly used to extract water from samples is methanol. The main ingredients of Dehydrated Solvents GEX and MS is methanol that has been thoroughly dehydrated. In general, these products can be used immediately to measure moisture content. In addition, a reaction accelerator has been added to make the reaction between Karl Fischer reagent and water occur more rapidly than with ordinary methanol. This allows measurements to be taken quickly and with a clear titration end-point.

[Uses]

Organic solvents (n-heptane, cyclohexane, xylene, toluene, benzene, ethyl acetate, N,N-dimethylformamide, etc.), inorganic chemicals, pesticides, pharmaceutical products, fertilizers, synthetic detergents, refrigerants, foodstuffs, etc.

[Characteristics]

- Minute amounts of water can be measured accurately.
- The reaction between water and the Karl Fischer reagent occurs rapidly.
- The end-point can be readily determined and measured over a short period of time.
- By first adding salicylic acid, it is possible to measure the moisture content of amines (strong basicity).

Reference: Muroi, K., Ono, M., Bunseki Kagaku 20, 975 (1971).

Dehydrated Solvents OL II and CM

Dehydrated Solvents OLII and CM are mixtures of dehydrated chloroform and dehydrated methanol, to which a reaction accelerant has been added. Applications include petroleum-related JIS and ASTM tests. These dehydrated solvents are ideal as solvents for petroleum products. They can also be used to dissolve resins, pharmaceutical products, rubber and other substances and can sometimes be used as titration solvents for these items.

[Characteristics]

- Petroleum products, resins and adhesives dissolve well in these products.
- The reaction between water and the Karl Fischer reagent occurs faster than with ordinary solvent mixtures.
- The end-point can be readily determined and measured over a short period of time.

[Applications]

Crude oil, electrical insulating oil, refrigerator oil, diesel oil, naphtha, gasoline, resins, adhesives, pharmaceutical products (caffeine, lecithin, ointments), printing inks, etc.

Dehydrated Solvents SU and FM

In the past the moisture content of sugars and foodstuffs was measured through drying at normal or low pressures. Measurement required long periods of time with these methods, however, and samples were frequently affected by heat decomposition. These drawbacks meant that the results did not always reflect the true moisture content. Measurements could not easily be taken even with the Karl Fischer method, since there was no suitable extraction solvent. Dehydrated Solvents SU and FM developed by Mitsubishi

Chemicals are mixtures of dehydrated formamide and dehydrated methanol, to which a reaction accelerant has been added. Substances that dissolve well in the main ingredient, formamide, include casein, glucose, starch and lignin. These solvents are therefore ideal for use in the extraction of moisture from sugars and foodstuffs.

[Characteristics]

- a) Sugars and protein dissolve well in these products.
- b) The reaction between water and the Karl Fischer reagent occurs rapidly.
- c) The end-point can be readily determined and measured over a short period of time.

[Applications]

Sugars (sugar, drops, caramel, butter sweets, black sugar sweets, malt syrup, syrup), gelatin (medical capsules, etc.), nucleic acid food additives, pharmaceutical products, dried vegetables, cereals, animal feeds, wool, etc.

Reference: Muroi, K., Tsutsui, C., Koizumi, H., Nihon Shokuhin Kogyo Gakkaishi 16, 39 (1969).

Dehydrated Solvent ME

The moisture content of gases can be measured indirectly using the physical or physical-chemical characteristics of water (see Q1), or by means of the Karl Fischer method, which involves a direct reaction with the water.

The Karl Fischer method is the more reliable, since the water is captured directly. It is widely used as the standard method and has been included in the JIS system and other systems.

Dehydrated Solvent was created as a moisture capturing solvent for use with gases. It is a mixture of dehydrated methanol and dehydrated ethylene glycol, to which a reaction accelerant has been added. Moisture content can be measured easily and accurately by passing a certain amount of gas through about 100ml of Dehydrated Solvent ME, followed by immediate titration using a Karl Fischer reagent.

Similar measurements can be obtained with a solvent prepared simply by mixing Dehydrated Solvent GEX or MS with propylene glycol in the ratio of 3:1 (by volume).

[Characteristics]

- a) The moisture content in gases can be captured completely, and there is minimal vaporization of the solvent even when large volumes of gas are passed through it.
- b) The reaction between water and the Karl Fischer reagent occurs rapidly.
- c) The end-point can be readily determined and measured over a short period of time.

[Applications]

Inorganic gases (hydrogen, nitrogen, oxygen, argon, helium, etc.) hydrocarbons (ethylene, acetylene, propylene, propane, butane, etc.) Vaporization solvent for plastics, minerals, greases, lubricants, etc. Also excellent for use with inorganic salts, which dissolve readily in this product.

Reference: Muroi, K., Ono, M., Sekiyu Gakkaishi [Journal of Japan Petroleum Society] 11 (No. 6), 440 (1968).
K. Muroi, Bunseki Kagaku 20, 975 (1971).

(2) Dehydrated Solvents used to Prevent Interference Reactions

Aldehydes or ketones that include active carbonyls cause interference reactions by reacting with methanol to produce water (see Q8). To prevent such reactions and measure moisture content accurately, it is necessary to use a dehydrated solvent designed for use with ketones.

The same dehydrated solvent can be used with lower carboxylic acid, which causes a similar reaction. Reactivity varies according to the specific substance and users should be aware that there are limitations on the size of the samples that can be measured.

Principal ingredients of solvent	Name	Use	Packaging
Propylene carbonate Diethylene glycol monoethyl ether	KTX(pyridine-free)	Ketones Lower carboxylic acid	500ml bottles
Chloroform Propylene carbonate	CP	Ketones Lower carboxylic acid Silicone oils	500ml bottles
Pyridine Ethylene glycol	PE	Special-purpose paints and varnishes	500ml bottles
Pyridine Propylene glycol	PP	Aldehydes	500ml bottles

Dehydrated Solvents KTX and CP

The method usually employed to measure the moisture content of substances that react with alcohol, such as ketones and silicon oils, involves the use of glycolic solvents which show relatively low reactivity, where generally used, at low temperatures. Dehydrated Solvent KTX is a pyridine-free titration solvent produced by mixing dehydrated propylene carbonate and diethylene glycol monoethyl ether. It should always be used in conjunction with Karl Fischer Reagent SS-Z. It cannot be used with aldehydes.

The main ingredients of Dehydrated Solvent CP are chloroform and propylene carbonate. With this blended solvent, the moisture content of substances such as ketones, aldehydes (except acetaldehydes) and silicone oils can be measured easily at room temperature.

[Characteristics]

- These solvents limit interference reactions with methanol, allowing ketones, aldehydes (except acetaldehydes), carboxylic acid, etc., to be measured at room temperature.
- These products can be used with aminobenzene group and are especially suitable for direct titration of aniline.
- These products can be used to measure trace moisture in silicone oils.

[Applications]

Acetone, methyl ethyl ketone, methyl isobutyl ketone, etc.
 Propionaldehyde, butyraldehyde, crotonaldehyde, etc.
 Aniline, cresidine, toluidine, anisidine, etc.
 Silicone oils

Dehydrated Solvent PE

Dehydrated Solvent PE is a mixture of dehydrated pyridine and dehydrated ethylene glycol, to which a reaction accelerator has been added. It is used at the amount of no more than 15ml of sample to 30ml of PE, accompanied by direct titration using Karl Fischer Reagent SS. With this product it is possible to suppress the interference reaction that is caused by ketones and to measure moisture content accurately. The solubility of pyridine, which is one of the main ingredients, also allows the product to be used for special applications, such as paints.

[Characteristics]

- This solvent allows direct titration of ketones and lower carboxylic acid.
- PE can be used as a titration solvent for paints, varnishes, etc.
- With this product the reaction between water and the Karl Fischer reagent occurs rapidly.
- The end-point can be readily determined and measured over a short period of time.

[Applications]

Acetone, cyclohexanone, methyl ethyl ketone, methyl isobutyl ketone, acetic acid, paints, varnishes, etc.

Reference: Muroi, K., Ogawa, K, Bunseki Kagaku 12, 963 (1963).

Dehydrated Solvent PP

Dehydrated Solvent PP is a mixture of dehydrated pyridine and dehydrated propylene glycol. As a result of work carried out by Mitsubishi Chemical in relation to active aldehydes, which present the greatest problem in terms of accurate measurement of moisture content, it is now possible to suppress two interference reactions (see Q9) and achieve precise measurement through direct titration with Karl Fischer Reagent SS, simply by adding no more than approximately 1ml of sample to 25ml of Dehydrated Solvent PP. In the case of acetaldehydes, which are the most active, about 5ml of sample is added to 25ml Dehydrated Solvent PP. The resulting mixture is then expelled with dried nitrogen and titrated.

[Characteristics]

This solvent allows direct titration of active aldehydes.

[Applications]

Acetaldehydes, n-butyraldehyde, iso-butyraldehyde, propionaldehyde, crotonaldehyde, other higher aldehydes

Reference: Muroi, K., Bunseki Kiki 3 (No.11), 40 (1965).

3. Standardization Reagents of Karl Fischer reagents

The titer of Karl Fischer Reagent SS-Z and SS can be standardized using water, standard water-methanol, standard water solution and sodium tetrataurate dihydrate. The most commonly used methods are those involving water, standard water-methanol and standard water solution. Standard water-methanol is also used as a titration agent for back titration. The following two standard water-methanol and standard water solution products are available.

Product	Application	Packaging
Standard water-methanol 2.0mg/ml	Standardization of Karl Fischer reagents with titer of 3-10mg/ml, reverse titration	250ml bottles
Aquamicon standard water 10mg	Standardization of Karl Fischer reagents with titer of 1-10mg/ml	10-ampoule cases

- Standard water-methanol must be stored in such a way that it cannot absorb moisture from the atmosphere.
- Once the seal is broken the moisture content may change because of atmospheric humidity.
The product should be re-standardized before use as a back titration.

! Helpful hint -5

Why is salicylic acid used to suppress the interference reaction caused by amines with strong basicity (pKa9 or higher)?

Interference reactions are observed when amines with strong basicity (pKa9 or higher) undergo direct Karl Fischer titration. Consequences of these reactions can include unstable end points and higher than normal analytical readings. To suppress these reactions, samples are first treated with acids to reduce the basicity. Traditionally, acetic acid was used, but this tended to trigger a reaction producing esters. Other problems include the fact that acetic acid itself has a high moisture content. Studies concerning the use of salicylic acid yielded promising results and the following advantages were identified.

- No esterification reaction during normal titration.
- Since methanol can be used as the titration solvent, Karl Fischer titration yields good results.
- Salicylic acid has a low moisture content.

The fact that salicylic acid is a solid, is a drawback. However, preparation simply involves the measurement of about 10g of salicylic acid into a titration flask and the addition of 50ml of Dehydrated Solvent GEX (or MS), then stirring until dissolved. Up to 70mmol of amines can be measured with 10g of salicylic acid.

.....

Q7 | What coulometric titration reagents are there? Please explain the types of reagents and their uses, and the methods employed.

Mitsubishi Chemical Corporation offers a range of coulometric titration reagents to suit user requirements. These products can be broadly categorized into the following four types.

<ul style="list-style-type: none"> •General-purpose electrolytes (three types) These are general-purpose reagents for use with normal samples.
<ul style="list-style-type: none"> •Ketone electrolyte (one type) This is used with ketones and lower carboxylic acid, etc.
<ul style="list-style-type: none"> •Check solution (one type) This product is used for end point checking.
<ul style="list-style-type: none"> •Standard liquid (three types) This reagent is used to check the moisture meters used in coulometric titration.

Advice to Users

Electrolytes are of two types; anolyte, which is placed in the anode chamber of the electrolysis cell, and catholyte, which is placed in the cathode chamber. Both these products form one pair.

Characteristics of the Aquamicron Series

When using the Aquamicron Series of electrolytes it is important to understand the following characteristics of the products.

- Very small quantities of water (about 10 μ g) can be measured accurately.
- Titration procedures are very simple.
- Measurements can be carried out quickly (1-10 minutes).
- It is not necessary to assess the titer of the reagent.
- The reagent can be used repeatedly.
- The composition of the solvents has been enhanced to make them suitable for immediate use with various samples. This eliminates the troublesome task of adding other solvents.

1. General-Purpose Electrolytes

The general-purpose Aquamicron Series of products are ideally constituted to facilitate Karl Fischer reactions with solvents, including methanol and propylene carbonate. Sample solubility is excellent, and even trace amounts of moisture can be extracted and titrated coulometrically with ease. These products also offer superior reagent stability, which is the most important requirement when measuring minute amounts of water. This means that measurements can be taken with good reproducibility.

The Aquamicron Series is suitable for a wide range of products including aromatics and other organic solvents, petroleum products, inorganic products and gas products.

They are also the ideal reagents for the water vaporization method. A particularly convenient feature is the fact that they can be used immediately without the need to add other solvents. Aquamicron products have an excellent reputation for use in day-to-day moisture measurement for plastics and other solid samples.

Product	Type	Packaging
Pyridine-free, chloroform-free Aquamicron AX Aquamicron CXU	Anolyte Catholyte	500ml glass bottles 5ml ampoules (10 per case)
Pyridine-free, chloroform-free Aquamicron AXI Aquamicron CXU	Anolyte Catholyte	500ml glass bottles 5ml ampoules (10 per case)
Pyridine-free Aquamicron AS Aquamicron CXU	Anolyte Catholyte	500ml glass bottles 5ml ampoules (10 per case)

2. Electrolytes for use with Ketones

Ketones are used as industrial solvents and for many other purposes.

Specially prepared Aquamicron products that do not contain methanol must be used for ketones because they trigger an interference reaction with the methanol in general-purpose Aquamicron products. The same specially prepared products are also excellent for use with lower carboxylic acid, which causes an esterification reaction with methanol.

Aquamicron products prepared for use with ketones can also be used with usual chemical substances such as alcohols. They should not be used with non-polar hydrocarbons or halogenated hydrocarbons which have low permittivity.

Product	Type	Packaging
Pyridine-free, chloroform-free Aquamicron AKX Aquamicron CXU	Anolyte Catholyte	500ml glass bottles 5ml ampoules (10 per case)

[Applications]

Acetone, methyl isobutyl ketone, methyl ethyl ketone, cyclohexanone, silicon oils, acetic acid, dichloroacetic acid, etc.

Reference: Muroi, K., Fujino, H., Sekiyu Gakkaishi [Journal of Japan Petroleum Society] 26, 97 (1983).

3. Check Solution P

Check Solution P is a solution of organic solvent containing a trace amount of water (approximately 4mg/ml). It is used to adjust the end point of coulometric titration by providing surplus water when free iodine is produced in the electrolytes. It can also be used for day-to-day inspections of coulometric titration systems. Since methanol is not used as the organic solvent, this product can also be used with both general-purpose Aquamicron products and products prepared for use with ketones.

Moisture Content	Packaging
3.8-4.2mg/ml	100ml glass bottles with septum caps

[Method of Use]

Used for day-to-day verification of moisture meter. This is done by precisely measuring the moisture content of the Check Solution P itself.

4. Water Standard Solution

Aquamicron Water Standard Solution is a water solution containing a standard amount of water. It is used to verify coulometric moisture meters and to determine the titer of KF reagents when used in volumetric moisture meters. The following products are available.

Product	Application	Packaging
Aquamicron Water Standard 0.1mg	Verification of moisture meters (coulometric titration)	5ml ampoules (10 per case)
Aquamicron Water Standard 0.2mg	Verification of moisture meters (coulometric titration)	5ml ampoules (10 per case)
Aquamicron Water Standard 1mg	Verification of moisture meters (coulometric titration)	5ml ampoules (10 per case)
Aquamicron Water Standard 10mg	Determination of titer of KF reagents (volumetric titration)	8ml ampoules (10 per case)

3. Applicability of Karl Fischer Titration

Q8 | What substances is Karl Fischer titration suitable for?

One of the most useful characteristics of Karl Fischer titration is its extremely wide range of applications.

- Organic compounds:
Karl Fischer titration can be used with almost all compounds.
- Inorganic compounds:
The scope of application is limited for a number of reasons, including the fact that inorganic compounds are generally difficult to dissolve in organic solvents and the fact that many react with Karl Fischer reagents. For this reason, the measurement of moisture content in inorganic compounds is commonly carried out using either the drying method or other procedures. However, the Karl Fischer method is useful for compounds that contain volatile substances and for compounds that are amenable to thermal decomposition.

The following are typical compounds that can be measured directly.

1. Organic compounds

- (1) Hydrocarbons
Saturated hydrocarbons, unsaturated hydrocarbons, aromatic hydrocarbons
- (2) Alcohols
Monohydric alcohols, polyhydric alcohols, phenols
- (3) Ethers
- (4) Acids
Monobasic acids, polybasic acids, sulfonic acids, hydroxy acids, amino acids
- (5) Esters
Organic acid esters, inorganic acid esters, carbamate esters
- (6) Aldehydes
Formaldehyde, chloral
- (7) Ketones

Normal ketones, diisopropyl ketone, benzophenone, benzoin, alizarin, quinalization, dibenzalacetone, camphor, etc.

(8) Acetals $\text{RCH}(\text{OR}')_2$

(9) Acid anhydrides $(\text{RC}=\text{O})_2\text{O}$

(10) Peroxides

Dialkyl peroxide

(11) Nitrogen compounds

Amines ($\text{pK}_a 9$ or lower)

Aminoalcohols

Amides RCONH_2

Nitriles RCN

Azo compounds $\text{RN}=\text{NR}'$

Imines RCHNR' Cyanhydrine $\text{RCH}(\text{OH})\text{CN}$

Oximes $\text{R}_2\text{C}=\text{N}'\text{OH}$

Lactam $\text{NH}(\text{CH}_2)_n\text{CO}$

Isocyanide compounds

Nitroso compounds $\text{R}_2\text{N}-\text{N}=\text{O}$, nitro compounds RNO_2

Cyanic acid derivatives $\text{HOC}=\text{N}$

Hydroxamic acid $\text{RC}-\text{NH}$



Anilides $\text{C}_6\text{H}_5\text{NHCOR}$

Purines, proteins

(12) Halogenated hydrocarbons

(13) Halogenated acyls

(14) Sulfur compounds

Thioether RSR , disulfides RSSR , thiocyanate compounds RSCN , isothiocyanates RNCS , thioesters RCOSR

2. Inorganic compounds

(1) Organic salts and their hydrates

Sodium acetate, potassium oxalate, sodium tartrate, Ammonium acetate, barium acetate, lead acetate, ammonium oxalate, etc.

(2) Inorganic salts and their hydrates

Alkaline salts of strong acids, sulfates, acidic sulfates, disulphates, dithionates, phosphates (I), phosphates (II)

(3) Acids

Sulfur dioxide, hydriodic acid, hydrochloric acid, hydrofluoric acid, nitric acid, sulfuric acid (92% or lower), phosphoric acid

(4) Chelate compounds

Cobalt complexes

(5) Polytungsten salts

Q9 | What is interference in the context of the Karl Fischer titration? Please explain what is meant by interference reactions.

Karl Fischer reagent reacts selectively with water, but its other constituents may react with substances other than water. In such cases, titration may fail to reach an end point, or an abnormal amount of Karl Fischer reagent may be consumed, leading to negative or positive errors in the analysis values. This type of phenomenon is called an interference reaction. It is necessary to be aware of this problem when using Karl Fischer titration.

Interference reactions can be broadly divided into the following two types.

- Reactions with iodine (or iodide ions)
- Reactions with other ingredients of Karl Fischer reaction (mainly methanol, sulfur dioxide)

The following are examples of substances that cause interference, and descriptions of the reactions that occur.

1. Reactions with iodine (or iodide ions)

The Karl Fischer method is a form of non-aqueous oxidation-reduction titration. Since the reaction between Karl Fischer reagent and water is a kind of iodometry, it is subject to interference by substances that trigger an oxidation-reduction reaction with iodine and iodide ions. Samples containing substances that react with iodine and iodide ions will therefore produce positive errors in measurements, while those that contain iodine produced through the oxidation of hydriodic acid, which is a reactive substance, will produce a negative error.

(1) Substances that consume iodine (reduction reaction) and cause a positive error

These are substances that react directly with free iodine in the Karl Fischer reagent. Because they consume iodine, they have the same effect as water, which means that the analysis results will be correspondingly higher.

1.1 Organic compounds

(a) Thiol (mercaptan), thiourea and their nitrogen substitutes

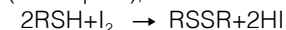

(b) Hydrazine hydrochloride

Hydrazine hydrochloride reacts on a mole by mole basis with iodine.

(c) Thio acid

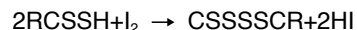

(d) Vinyl ether and 2,3-dihydrofuran, dihydroprane

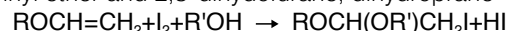

(e) Ascorbic acid (Vitamin C)

(f) Amines and aminoalcohols (pKa9 or higher)

These consume iodine gradually.

1.2 Inorganic compounds

(a) Ammonia

This reacts with iodine to produce nitrogen iodide

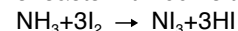

(b) Hydroxylamines

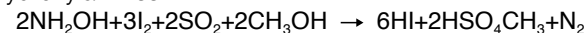

(c) Ferric chloride

Iron(III) salt causes the following reaction, with the result that only 5.5 molecules of water are titrated.

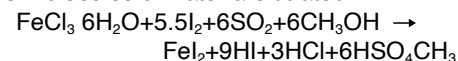

(d) Metal oxides

Manganese dioxide, ferric oxide and lead dioxide react with Karl Fischer reagent. However, the reaction is not quantitatively constant, since these substances do not dissolve readily in the reagent.

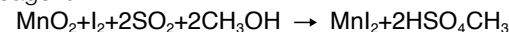

However, interference does not occur with hydrogen peroxide, sodium peroxide, barium peroxide, potassium persulfate or ammonium persulfate, since these substances react selectively with sulfur dioxide.

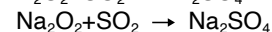
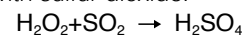

(e) Weak acids and oxides

Boric acid, metaboric acid, boron oxide and arsenic trioxide all react with Karl Fischer reagent.

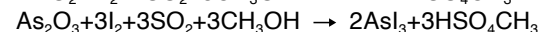
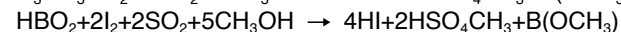
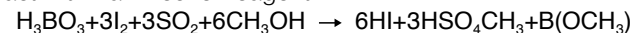

(f) Salts

In general, the weakly acidic salts of alkaline metals react with Karl Fischer reagent in the same way as oxides.

Carbonates, bicarbonates, sulfites and pyrosulfites react in approximately constant amounts.

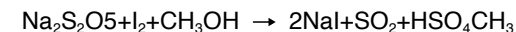
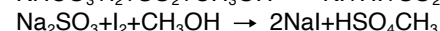
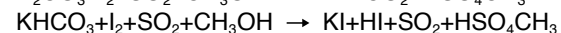
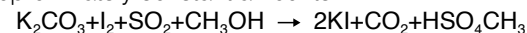

Sodium tetraborate ($\text{Na}_2\text{B}_4\text{O}_7$) and sodium metaarsenite

react in approximately the same quantities as shown in (d).

The following are examples of salts that cause nonquantitative reactions with Karl Fischer reagent, and salts

for which the reaction mechanism is not fully understood.

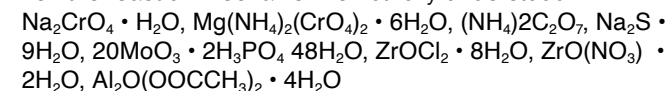

(g) Reducing agents

When strong reducing agents are titrated, the amount of moisture will be higher. Stannous chloride and sodium thiosulfate react with Karl Fischer in approximately constant quantities.

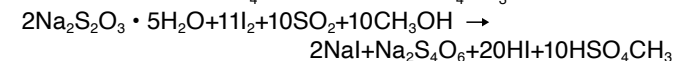
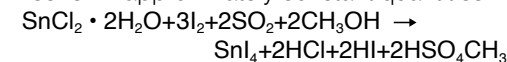

Sodium sulfide also reacts with iodine.

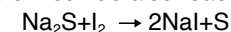

(2) Substances that produce iodine (oxidation reactions) and cause a negative error

(2.1) Organic compounds

(a) Dichloroisocyanuric acid

Iodine is freed through the oxidation of hydriodic acid.

(b) Quinone

Iodine is freed through the oxidation of hydriodic acid.

(c) Peroxy acid

Iodine is freed through the oxidation of hydriodic acid.

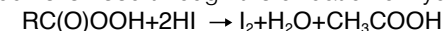

(d) Peroxides (dialkyl)

Iodine is freed through the oxidation of hydriodic acid

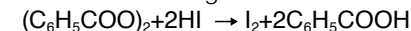

(2.2) Inorganic compounds

(a) Chlorine

Iodine is freed through the oxidation of hydriodic acid

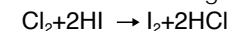

(b) Oxidizing agents

Moisture content appears lower when strong oxidizing agents are measured.

(3) Substances that react with hydriodic acid and produce water

Metal oxides and hydroxides.

Oxides and hydroxides of alkaline metals and alkaline earth metals react in approximately constant quantities with the hydriodic acid in Karl Fischer reagent.

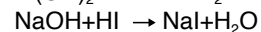
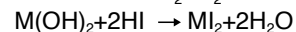
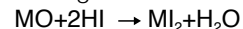

e.g. MgO, ZnO, Ag₂O, HgO, Cu₂O, LiOH, KOH, Ba(OH)₂, etc.

However, weakly acidic oxides react much less.

Substances that do not react at all include Al₂O₃, CuO, NiO and PbO.

Oxides that react in constant amounts dissolve completely in the Karl Fischer at the titration end point, but Ni and Al compounds do not dissolve.

2. Other Substances that react with ingredients of Karl Fischer Reagents

If methanol is used as the solvent for Karl Fischer reagent and the titration solvent, the following interference reactions will occur. In the case of aldehydes, there will be interference resulting from reactions with both sulfur dioxide and water.

(1) Carbonyl compounds

The following reactions with alcohol cause interference by producing water, leading to high analysis results. Frequently, the end point will never be reached.

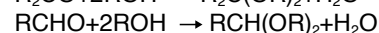

In addition to these reactions, aldehydes also capture water through the following interference reaction. This results in low analysis results.

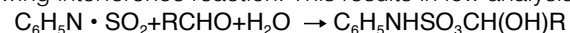
**(2) Lower carboxylic acids and their derivatives**

Formic acid, acetic acid, monochloroacetic acid and dichloroacetic acid trigger an esterification reaction with methanol at room temperature (20°C) or higher. This reaction causes interference by gradually producing water.

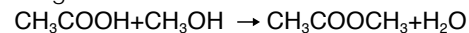

Formic acid in particular is not suitable for Karl Fischer titration.

(3) Silanol and silanol derivatives

If methanol is present during Karl Fischer titration, the silanol in silicon oils will trigger the following interference reaction.

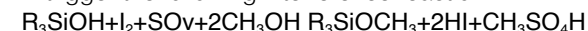

Q10 Please outline any methods that can be used to suppress interference reactions so that Karl Fischer titration can be employed.

The countermeasures used to suppress interference depend on the type of interference reaction.

- Basically, Karl Fischer titration cannot be used with substances that cause oxidation/reduction reactions. Special preliminary processes must therefore be used to convert these substances into other substances before titration.
- Where substances react with methanol, Karl Fischer titration is carried out under conditions that do not involve the use of methanol. With Karl Fischer Reagent SS-Z and SS, methanol is not used as the solvent, so it is possible to measure the water content in carbonyl compounds and other substances simply by using the reagent in conjunction with a dehydrated solvent formulated for use with ketones. These expanded range of uses greatly enhances the value of these products.
- In the case of interference substances that do not change when heated, it is possible to carry out Karl Fischer titration by using a water vaporization system.
- With substances that have strong basicity, such as amines, it is possible to use Karl Fischer titration if the substances are first neutralized by adding acid.

Specific examples are shown in the following tables. Individual researchers should optimize their approaches on the basis of these examples.

1. Substances requiring special treatment

Compound	Treatment
Ammonia	Add acetic acid.
Ferric salts	Add 8-Hydroxyquinoline.
Hydrazine derivatives	Add acetic acid.
Hydroxylamine salts	Add sulfur dioxide:pyridine solution (1:1).
Thiol (mercaptan)	Prevent interference by adding olefins (octene, etc.).
Sulfuric acid	If the sulfuric acid is 92% pure or higher, add a large surplus of pyridine and titrate it as a salt.
Thio acid	Prevent interference by adding olefins (octene, etc.).
Thiourea	Prevent interference by adding olefins (octene, etc.).

2. Using Karl Fischer reagents with interference substances

With ketones, aldehydes, lower carboxylic acid and amines with strong basicity, titration should be carried out using the Karl Fischer reagent in conjunction with the reagents shown below.

Substance	Reagent Used		
	Volumetric titration		Coulometric titration
Ketones	Karl Fischer Reagent SS-Z	Dehydrated Solvent KTX	Aquamicon AKX
	Karl Fischer Reagent SS	Dehydrated Solvent CP	Aquamicon CXU
Aldehydes	Karl Fischer Reagent SS-Z	Dehydrated Solvent KTX	Aquamicon AKX
	Karl Fischer Reagent SS	Dehydrated Solvent CP	Aquamicon CXU
	Karl Fischer Reagent SS	Dehydrated Solvent PP	(suitable only for certain aromatic aldehydes)
Low-grade carboxylic acid	Karl Fischer Reagent SS-Z	Dehydrated Solvent KTX	Aquamicon AKX
	Karl Fischer Reagent SS	Dehydrated Solvent CP	Aquamicon CXU
Strong-base amines (pKa9 and above)	Karl Fischer Reagent SS-Z	Dehydrated Solvent GEX + salicylic acid	Aquamicon AX + salicylic acid
	Karl Fischer Reagent SS	Dehydrated Solvent MS + salicylic acid	Aquamicon CXU

Note: Do not use Karl Fischer SS with Dehydrated Solvent KTX.

Measuring Moisture Content of Strong-Base Amines

Put 10g of salicylic acid into a titration flask (electrolysis cell). Add 50ml of Dehydrated Solvent GEX or MS (100ml in the case of Aquamicon AX) and mix together. Add the sample (amine) after dehydrating it with Karl Fischer reagent. Then initiate Karl Fischer titration. The amount of sample that can be measured will vary according to the type of amine.

4. Procedures for Karl Fischer Titration

Q11 | How should we actually carry out volumetric titration? Please describe the preparations and procedures involved.

To measure moisture content by means of volumetric titration, you will first need to prepare the following items.

- Titration agent: Karl Fischer Reagent SS-Z (or SS)
(It is necessary to assess the titer before use.)
- Titration solvent: Select the dehydrated solvent to suit the samples.
- A Karl Fischer volumetric titration system
(Reagents manufactured by Mitsubishi Chemical can be used with any commercially available system.)

Next, the amount of the sample is determined according to the anticipated moisture content.

In general, one of the following three methods of titration are used. The procedures for each are explained below.

- (1) Direct titration
- (2) Back titration
- (3) Water vaporization

1. Sample Size

It is important to determine the size of the sample according to the moisture content. If there is excessive moisture, Karl Fischer reagent will be wasted, and if there is too little, there will be significant effect on titration error and the results will lack precision. The following table can be used as a guide when determining the appropriate amount of sample in relation to anticipated moisture content. The figures shown here assume that the Karl Fischer reagent has a titer of 3mg/ml. If the titer is different, it will be necessary to adjust the figures accordingly.

Anticipated moisture content (%)	Amount of Sample (g)
0.1 or lower	10-20
0.1-0.5	5
0.5-1	2
1-5	0.5
5-10	0.3
10-50	0.1
50 or higher	0.03

2. Direct titration (standard method)

This is the standard and most commonly used method of volumetric titration. The sample is dissolved in a dehydrated solvent and titrated with Karl Fischer reagent. Titration is carried out in a sealed system isolated from the atmosphere.

[Procedures]

- Place 25-50ml of dehydrated solvent in a thoroughly dried flask.
- Titrate the Karl Fischer reagent SS-Z to the end point to remove all moisture. (This procedure is known as "pre-titration". It is not necessary to read the titration volume at this stage.)
- Measure out the sample (A, g) according to the anticipated moisture content and immediately place it in a titration flask.
- Titrate to the end point (B, ml) using Karl Fischer SS-Z for which the titer (F, mg/ml) is known, stirring continuously.
- Calculate the moisture content (W, %) according to the following formula.

$$W = \frac{B \times F}{A \times 1000} \times 100$$

3. Back Titration

In the case of solid samples that cannot readily be dissolved in dehydrated solvents, moisture is extracted by stirring for a specific period. An excess of Karl Fischer reagent is then added and the sample is left for a specific period to allow the moisture to react thoroughly with the reagent. The excess Karl Fischer reagent is then subjected to back titration using standard water/methanol solution.

[Procedures]

- All moisture is removed from the dehydrated solvent using the procedures described in the previous section.
- The sample (A', g) is immediately placed in a titration flask.
- A specific amount (C, ml) of excess Karl Fischer reagent SS-Z (titer F' mg/ml) is then added and the sample is stirred for the required period of time.
- The sample is then titrated to the end point (D, ml) using a standard water/methanol solution (titer f, mg/mg).
- Moisture content (W', %) is calculated according to the following formula.

$$W' = \frac{(C \times F') - (D \times f)}{A' \times 1000} \times 100$$

4. Moisture Vaporization Method

The moisture vaporization method is used with solid samples that do not readily dissolve in dehydrated solvents, or for samples that cause interference reactions. Moisture vaporization is carried out using a commercially available moisture vaporization system in combination with a volumetric titration system.

[Procedures]

- An oven is maintained at a temperature suitable for vaporizing the moisture content of the sample. Nitrogen gas, which has previously been passed through a drying tube, is passed through the moisture vaporization system at a rate of approximately 200ml/min.
- The titration system is dehydrated by means of pre-titration in the titration system in a flow of nitrogen gas.
- The sample is then quickly transferred to a sample boat and placed in an oven that has been maintained at the required temperature.
- The vaporized water is absorbed into a dehydrated solvent (GEX, MS or ME).
- Karl Fischer titration is then carried out according to the direct titration method.

Note: Dehydrated solvent GEX or MS should be used in a mixture consisting of one part of propylene glycol to three parts of dehydrated solvent by volume.

5. Determining Titer

The titer of the Karl Fischer reagent SS-Z (or SS) that is placed in the titration system must always be determined before use. Karl Fischer reagent SS-Z (or SS) is very stable and needs to be tested only once a week, provided that the bottle is kept airtight. Where particularly high accuracy is required, titer should be checked daily. Titer can be determined using one of the following four methods.

- Using pure water
- Using standard water solution
- Using standard water/methanol solution
- Using sodium tartrate dihydrate

The characteristics of these methods and the procedures for using them are described below.

(1) Using pure water

This method is the most accurate, since the standard for determining titer is water itself. The drawback with this method is the difficulty of measuring small amounts of water accurately. A microsyringe is used for conveying the water. It is convenient to use a commercially available dropping bottle with a small dripping pipette. Each drop from the pipette is 20-30mg.

[Procedures]

The amount of water obtained should be 10-30mg. The procedures are the same as for direct titration. The following calculation formula is used.

$$F = S/T$$

Where F: Titer (mg/ml)

S: Amount of water obtained (mg)

T: Amount of Karl Fischer reagent required for titration (ml)

(2) Using standard water solution

With this method, a standard water solution with a guaranteed value is used in place of water. Where the value of the standard water solution is around 10mg/g, approximately 1g is obtained. The following calculation formula is used.

$$F = S \times K/T$$

Where F: Titer (mg/ml)

S: Amount of standard water solution obtained (g)

K: Guaranteed value of standard water solution (mgH₂O/g)

T: Amount of Karl Fischer reagent required for titration (ml)

(3) Using standard water/methanol solution

Standard water/methanol solution is a standard water solution for which the moisture content has been accurately determined. It is especially suitable for determining the titer of Karl Fischer Reagent SS-Z (or SS). The moisture content is shown in the label (e.g. 2.02mg/ml).

[Procedures]

- a) 25-50ml of dehydrated solvent GEX (or MS) is placed in a titration flask.
- b) Karl Fischer Reagent SS-Z (or SS) is titrated to the end point to remove all moisture content. (It is not necessary to read the titration value at this stage.)
- c) 5-10ml of standard water/methanol solution is taken and added to the dehydrated solvent in the titration flask.
- d) The Karl Fischer Reagent SS-Z (or SS) that is to be assessed is titrated.
- e) Titer is calculated from the titration volume according to the following formula.

$$F = A \times f/B$$

Where F: Titer of Karl Fischer Reagent SS-Z (or SS) (mg/ml)

A: Amount of standard water/methanol solution obtained (ml)

f : Titer of standard water/methanol solution (mg/ml)

B: Amount of Karl Fischer Reagent SS-Z (or SS) titrated (ml)

Note:Standard water/methanol solution has the same expansion coefficient as methanol. If it is used at a temperature that is significantly different from the assessment temperature shown on the label (20°C), it will be necessary to correct the volume (ml) of standard water/methanol solution used.

(4) Using sodium tartrate dihydrate

Sodium tartrate dihydrate is the most stable of the hydrate standard substances in relation to changes in atmospheric humidity. It has a theoretical moisture content of 15.66%. The low solubility of commercially available sodium tartrate dihydrate means that large amounts cannot be obtained. The amount for 50ml of methanol would be about 200mg or less.

Users should be aware that the crystal size of commercially available products may vary. If the crystals are too small they may scatter when added, leading to errors.

[Procedures]

The amount of sodium tartrate dihydrate obtained should be around 150mg.
The procedures are the same as for direct titration.
The following calculation formula is used.

$$F = m \times 0.1566 / V$$

Where F: Titer (mg/ml)
m: Amount of sodium tartrate dihydrate obtained (mg)
V: Amount of Karl Fischer reagent required for titration (ml)

! Helpful hint -6

Why does a solution that reached the titration end point change color if it is left standing?

If a solution is left standing for a period after it has reached the titration end point, it will turn yellow and will start to consume Karl Fischer reagent again. Conversely, it may turn the reddish brown color associated with overtitration. This phenomenon results from contamination by external moisture, and from the free iodine from the iodide in the solution through the action of ultraviolet rays and oxygen.

Q12 | How can we actually measure moisture content using coulometric titration? Please describe the preparations and procedures involved.

To measure moisture content by means of coulometric titration, you will first need to prepare the following items.

- Electrolytes: Aquamicon series
To ensure proper functioning, it is essential to use the correct anolyte-catholyte combination.
- A Karl Fischer coulometric titration system
(Aquamicon series products manufactured by Mitsubishi Chemicals can be used with most commercially available systems.)

Next, the size of the sample is determined according to the anticipated moisture content.

There are actually two coulometric titration methods.

- (1) Direct titration (2) Moisture vaporization

1. Sampling amounts

Coulometric titration is suitable for the measurement of trace quantities of moisture. Sample size is an important consideration as excessive quantities will extend the time required for analysis.

Normally a sample containing 0.1-5mg of water is used. The guidelines in the following table assume that the appropriate moisture content range for coulometric titration is 1% or lower. This is not to say that coulometric titration cannot be used for samples with a moisture content above 1%. In such cases, however, the need to obtain samples in extremely small quantities will increase measurement errors, leading to problems with accuracy. If possible, volumetric titration should be used in such cases.

Anticipated moisture content (%)	Sample quantity (g)
0-0.05	5-10
0.05-0.1	2
0.1-0.2	1
0.2-0.5	0.5
0.5-2.0	0.1

2. Obtaining a Sample

A carefully dried syringe (1-10ml) should be used. First, flush the syringe 2-3 times with the sample substance. Next, the amount required for the sample should be taken. A piece of silicon rubber should be attached to the end of the syringe needle, and the syringe should then be weighed precisely.

The silicon rubber should then be removed, and the sample inserted into the

system. The rubber should then be replaced, and the syringe weighed again. The difference in weights should be equal to the weight of the sample.

3. Combination of Aquamicon Products

	General use	With ketones
Anolyte	Aquamicon AX or Aquamicon AS	Aquamicon AKX
Catholyte	Aquamicon CXU	Aquamicon CXU

4. Direct Titration

This method is suitable for liquid, solid or gaseous substance that can be dissolved in Aquamicon. Direct titration should not be used for insoluble solid samples since these may clog the membranes or affect the efficiency of the current.

[Procedures]

- Approximately 100ml of anolyte (Aquamicon AX, AS or AKX) is placed in an electrolyte cell (Figure 3) that has been carefully dried.
- The entire contents of a catholyte ampoule (Aquamicon CXU, 5ml) is placed in the catholyte chamber.
- An electrolytic current is applied to the anode-cathode while it is stirred to produce iodine and trigger the Karl Fischer reaction in order to remove all water from the electrolysis cell. (It is not necessary to read the moisture content at this stage.)
- The sample is introduced into the electrolysis cell and coulometric titration is then carried out until the end point.
- Moisture content is calculated according to the following formula.

$$W1=M/S$$

$$\text{or } W2=M \times 100/(S \times 10^6)$$

Where W1: Moisture content (ppm)

W2: Moisture content (%)

M: Measurement value ($\mu\text{gH}_2\text{O}$)

S: Amount of sample (g)

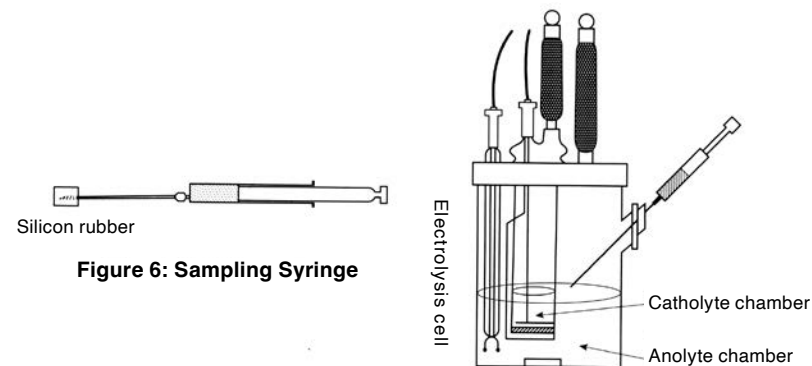

5. Moisture Vaporization

With this method, the coulometric titration system is used in conjunction with a moisture vaporization system. Approximately 150ml of anolyte (Aquamicon AX or AS) is placed in an electrolysis cell. Two ampoules (10ml) of catholyte (Aquamicon CXU) are used.

The condition for moisture vaporization should be optimized for the particular sample. Detailed instructions for various types of samples are provided later in this manual.

Q13 | Sampling procedures are one of the most important aspects of moisture content measurement. What are the specific methods and equipment involved?

At a room temperature of 25°C with 50% humidity, the moisture content of the atmosphere is 0.01mg per 1ml. Depending on the procedures used, moisture (humidity) may infiltrate the electrolysis cell (or titration flask), adhere to the equipment used to obtain samples, or dissolve in the sample. It is important to be aware of this possibility as it can lead to error.

It is also essential to vary sample quantities in accordance with individual characteristics and moisture content. It is convenient to use commercially available sampling equipment of the types shown in Figures 9-17. These are designed to allow samples to be varied according to the particular circumstances. The procedures for using this equipment are described below.

1. Liquid Samples

Equipment used with liquid samples includes micro-syringes, syringes, pipettes and dropper bottles.

(1) Micro-syringes

Micro-syringes are used to obtain specific amounts of water, substances with a high moisture content, or check solutions for coulometric titration.

Products are available commercially with capacities of 10, 25, 50 and 100ul. The needle should be as long as possible. Most commercial products have 50mm needles. The following precautions should be taken when using micro-syringes.

- Where possible, avoid using the full stroke of the micro-syringe when measuring the sample. We recommend using 2/3 or less of the stroke. (This is because the plunger could be contaminated by atmospheric moisture.)
- Dry the micro-syringe thoroughly. After the micro-syringe has been washed with an organic solvent (methanol, etc.) with a low boiling point, it should be thoroughly dried in a flow of dried nitrogen, etc., and then placed in a drier.
- Flush the micro-syringe 2-3 times with the sample.
- When adding the sample, push the plunger down quickly to ensure that no sample remains on the tip of the needle.

Sometimes samples are tested by weight using the same procedures as with syringes. The weight of the sample normally should be determined from measurements of volume and relative gravity (or density).

(2) Syringes

These are used for most liquid samples. Glass syringes are most commonly used, however plastic products (disposable) are also convenient. The most commonly used commercial products are 1, 2, 5 and 10ml syringes. General procedures for using syringes are described below.

- After carefully drying the syringe (figure 6), flush it two or three times with small amounts of the sample. Then draw in the required amount of the sample.
- Attach a piece of silicon rubber to the needle and weigh the syringe.
- Remove the silicon rubber and insert the syringe needle through the stopper attached to the side valve of the titration cell (Figure 8). Inject the sample.
- Pull out the syringe needle and weigh it accurately with the piece of silicon rubber attached to the needle.
- The difference between the two weights is the weight of the sample.

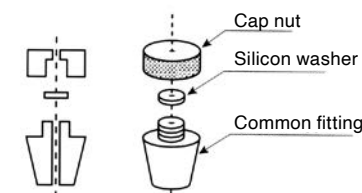

Figure 8: Stopper

(3) Pipettes

Because a stopper cannot be used with a pipette, the side stopper (or sample injection stopper) must be removed. With the stopper removed the experiment is exposed to the air and the results must be corrected for the infiltration by atmospheric moisture by conducting a blank test for the same period of time that the flask was open. The method is unsuitable, therefore, for the coulometric titration used to measure trace amounts of moisture.

The weight of the sample is determined by separate measurement of the relative gravity (or density). We recommend the use of syringes wherever possible.

(4) Dropper bottle

Dropper bottle (Figure 9) are used for water or for samples with a high moisture content. They are especially convenient for measuring water when determining the titer of Karl Fischer Reagent SS-Z (or SS) using water. With commercially available products, the pipettes produce droplets of about 30mg each.

[Procedures]

- After carefully drying the dropper bottle, introduce the sample. Attach the pipette and extract the sample.
- Accurately weigh all the equipment.
- Remove the pipette from the dropper bottle and titrate the titration solvent.
- Replace the pipette on the dropper bottle and weigh the equipment accurately.
- The difference between the two weights is the weight of the sample.

(5) Dropper bottle (for high-viscosity substances)

This equipment (Figure 10) is used for samples with the viscosity of treacle. Procedures are the same as in (4) above.

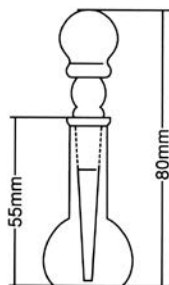

Figure 9: Dropper bottle

Figure 10: Dropper bottle
(for high-viscosity substances)**2. Solid Samples**

The appropriate method must be selected with reference to the varying characteristics and forms of solid samples. There are commercial products that are suitable for each method and it is convenient to use these.

As the sample insertion aperture on the titration flask must be opened to insert the sample, a blank test must be carried out to adjust for the time while the flask is open. In general, the following procedures are used.

- Obtain the required amount of sample using a thoroughly dried sampling bottle.
- Accurately weigh the sampling bottle.
- Remove the stopper of the sample insertion aperture on the titration flask and quickly insert the sample.
- Close the stopper and record the time that stopper was open. (The lid should be opened for exactly the same period of time during the blank test.)
- Weigh the sampling bottle.

(1) Upright solid sampling bottle

An upright solid sampling bottle (Figure 11) is used for ordinary powdered, granular or lumpy samples. This type of sampling bottle is used frequently.

(2) Angled solid sampling bottle

A drawback with upright sampling bottles is that the sample must be shaken to some extent to make it drop to the bottom. The angled bottle solves this problem by means of a half-rotational bend that allows the sample to fall (Figures 12, 13). The angled-neck bottle is especially suitable for plastic pellets.

(3) Trace solid sampling bottle

This container (Figure 14) is used to obtain extremely small amounts of samples with a high moisture content. It is suitable for powdered samples.

(4) Syringe-type sampling bottle

The syringe-type sampling bottle (Figure 15) is used for consolidated powders and viscous solids. The sample is drawn into the syringe by pulling out the plunger, and then expelled the contents into the system by pushing in the plunger.

(5) Sampling bottle for semi-solids

This container (Figure 16) is used for high-viscosity samples, such as greases. The sample is first taken onto the sampling spoon (A), which is then weighed together with the bottle (B). Next, the sample is inserted into the titration flask together with the sampling spoon. The spoon is stirred for a period to allow the sample to dissolve. On completion of the measurement the sampling spoon is returned to the sampling bottle, which is then weighed. The difference between the two weights is the weight of the sample.

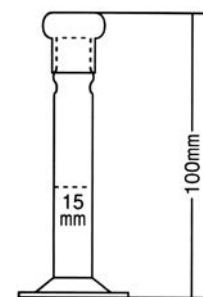
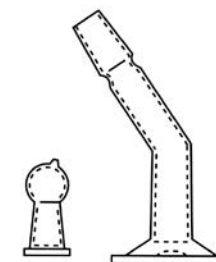
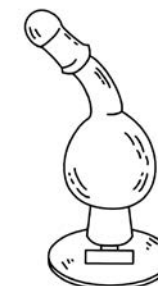
Figure 11:
Upright Sampling BottleFigure 12:
Angled Sampling BottleFigure 13:
Angled-neck Sampling Bottle

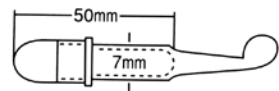

Figure 14: Trace Sampling Bottle

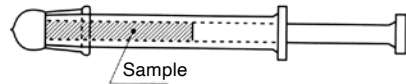

Figure 15: Syringe-Type Sampling Bottle

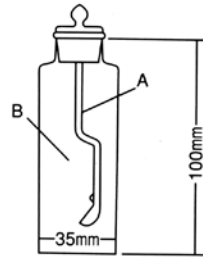

Figure 16: Semi-Solid Sampling Bottle

3. Liquefied Gas Samples

A dual-aperture pressurized sampling bottle and stainless steel pipes are used. Commercial products are available to suit specific purposes and these are recommended.

The key requirement for sampling is to ensure that the liquid phase is introduced into the dehydrating solvent (or electrolyte). Errors may result if only the gaseous phase is introduced. Also, the entire amount of sample must be added. The general procedures are summarized below.

- Position the gas bottle upright or at an angle.
- Connect a pipe between the gas bottle and the sampling bottle.
- Introduce the liquid phase into the sampling bottle.
- Keep the amount of the sample to 80% or less of the vessel's capacity and determine the weight.

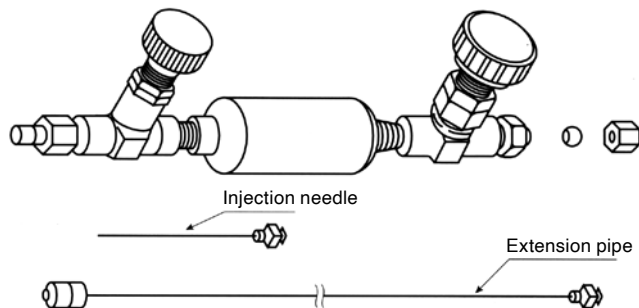

Figure 17: A Typical Sampling Bottle

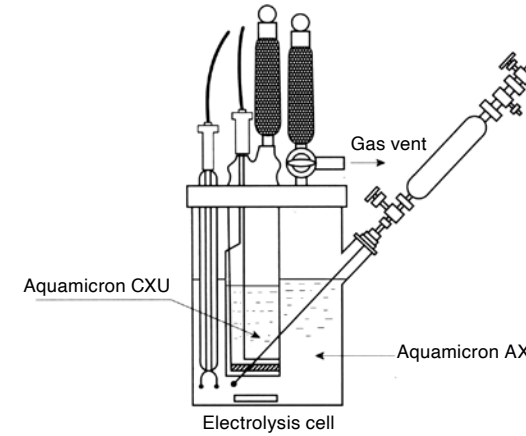

Figure 18: Example of an Injection Assembly

.....

5. Official Testing Methods and Documentation

Q14 | Karl Fischer titration is classed as an official testing method. What Japanese standards have been adopted?

Karl Fischer Reagent SS-Z (or SS), dehydrating solvent, and the Aquamicron series of products all comply with Japanese standards and can be used with confidence.

1. Japanese Industrial Standards (JIS)

JIS	Name of Standard	Cited Standards
C2101	Testing methods for electrical insulating oils.	
K0068	Test methods for water content of chemical products	
K0113	General rules for methods of potentiometric, amperometric, coulometric, and Karl-Fischer titrations	
K1422	Carbon tetrachloride	K0068, K0113
K1424	Ammonium nitrate	K0068
K1508	Trichloroethylene	K0068, K0113

K1521	Perchloroethylene	K0068,K0113
K1522	Isopropyl alcohol	K4101
K1557-2	Plastics -- Polyols for use in the production of polyurethanes -- Part 2: Determination of moisture content	K0068
K2211	Refrigerating machine oils	K2275
K2220	Lubricating grease	K2275
K2234	Engine antifreeze coolants	K0068
K2242	Heat treating oils	K3362
K2275	Crude oil and petroleum products - Determination of water content	K0113
K2436	Naphthalene, anthracene, carbazole	K0068,K0113
K2437	Phenols	K0068,K0113
K2438	Pyridine bases	K0068,K0113
K3351	Glycerines for industrial use	K0068
K3362	Testing methods for synthetic detergent	K0068
K4101	General testing methods for organic intermediates	K0113
K4108	Nitrobenzenes	K0113
K4109	Aminobenzenes	K0113
K4112	N-Substituted anilines	K0113
K4127	Benzoic acid	K0113
K4129	Naphthol	K0113
K4132	1-Naphthylamine	K0113
K4137	Anisidine	K0113
K4148	Dinitrobenzenes	K0113
K4153	Diphenylamine	K0113
K4156	Nitrophenols	K0113
K4809	Analytical methods of explosives	
K6724	Vinyl Acetate	
K6759	Testing methods for acrylonitrile	
K6910	Testing methods for phenolic resins	
M8001	General testing methods for reagent chemicals	
M8211	Iron ores-Method for determination of combined water content	K0113
K8231	Method for determination of combined water in manganese ores	

2. Japan Pharmaceutical Codex (Revision 17)

General Test Method 2.48: Moisture Content Test (Karl Fischer Method)

The items listed in the Pharmaceutical Codex that stipulate the use of moisture content testing by means of Karl Fischer reagent are as follows.

Item	Tolerance (sample amount)
Aclarubicin Hydrochloride	3.5% or lower(0.1 g, Volumetric, Direct titration).
Acrinol Hydrate	4.5 ~ 5.5%(0.2 g, Volumetric, Direct titration).
Aciclovir for Injection	7.5% or lower(0.1 g, Volumetric, Direct titration).
Azithromycin Hydrate	4.0 ~ 5.0%(0.4 g, Volumetric, Direct titration).
Aztreonam for Injection	2.0% or lower(0.5 g, Volumetric, Direct titration).
Aspirin Aluminum	4.0% or lower(0.15 g, Volumetric, Direct titration).
Aspoxicillin Hydrate	9.5 ~ 13.0%(0.2 g, Volumetric, Direct titration).
Aminophylline Hydrate	7.9% or lower(0.3 g, Volumetric, Direct titration).
Amlodipine Besilate	0.5% or lower(1 g, Volumetric, Direct titration).
Amoxicillin Hydrate	11.0 ~ 15.0%(0.1 g, Volumetric, Direct titration).
Amoxicillin Capsules	15.0% or lower(0.1 g, Volumetric, Direct titration).
Amosulalol Hydrochloride	4.0% or lower(1 g, Volumetric, Direct titration).
Argatroban Hydrate	2.5 ~ 4.5%(0.2 g, Volumetric, Direct titration).
Alprostadil Alfadex	6.0% or lower(0.2 g, Volumetric, Direct titration).
Anhydrous Ampicillin	2.0% or lower(2.5 g, Volumetric, Direct titration).
Ampicillin Hydrate	12.0 ~ 15.0%(0.1 g, Volumetric, Direct titration).
Ampicillin Sodium	2.0% or lower(0.2 g, Volumetric, Direct titration).
Ampicillin Sodium for Injection	3.0% or lower(0.2 g, Volumetric, Direct titration).
Ampicillin Sodium and Sulbactam Sodium for Injection	2.0% or lower(0.5 g, Volumetric, Direct titration).
Iotroxic Acid	4.0% or lower(0.3 g, Volumetric, Direct titration).
Isepamicin Sulfate	12.0% or lower(0.2 g, Volumetric, Direct titration).
Isosorbide	1.5% or lower(2 g, Volumetric, Direct titration).
Isopropanol	0.75 w/v% or lower(2 mL, Volumetric, Direct titration).
Isomalt Hydrate	7.0% or lower(0.3 g, Volumetric, Direct titration).
Idarubicin Hydrochloride for Injection	4.0% or lower (Volumetric, Direct titration).
Ibuprofen Piconol	0.1% or lower(5 g, Volumetric, Direct titration).
Irbesartan	0.5% or lower(1 g, Volumetric, Back titration).
Ecabet Sodium Hydrate	17.3 ~ 19.2%(0.2 g, Volumetric, Direct titration).
Ethylmorphine Hydrochloride Hydrate	8.0 ~ 10.0%(0.25 g, Volumetric, Direct titration).
Calcium Sodium Edetate Hydrate	5.0 ~ 13.0%(0.2 g, Volumetric, Direct titration).
Ethosuximide	0.5% or lower(2 g, Volumetric, Direct titration).
Etoposide	4.0% or lower(0.5 g, Volumetric, Direct titration).
Epirubicin Hydrochloride	8.0% or lower(0.1 g, Volumetric, Direct titration).

Erythromycin	10.0% or lower(0.2 g, Volumetric, Direct titration).	Sultamicillin Tosilate Hydrate	4.0 ~ 6.0%(0.5 g, Volumetric, Direct titration).
Erythromycin Ethylsuccinate	5.0% or lower(0.5 g, Volumetric, Direct titration).	Sulbactam Sodium	1.0% or lower(0.5 g, Volumetric, Direct titration).
Erythromycin Stearate	5.0 mL or lower(0.5 g, Volumetric, Direct titration).	Sulbenicillin Sodium	6.0% or lower(0.5 g, Volumetric, Direct titration).
Erythromycin Lactobionate	5.0% or lower(0.5 g, Volumetric, Direct titration).	Human Menopausal Gonadotrophin	5.0% or lower(0.2 g, Volumetric, Direct titration).
Enflurane	0.10% or lower(10 g, Volumetric, Direct titration).	Cefaclor	6.5% or lower(0.2 g, Volumetric, Back titration).
Oxycodone Hydrochloride Hydrate	12 ~ 15%(0.2 g, Volumetric, Direct titration).	Cefaclor Capsules	8.0% or lower(0.2 g, Volumetric, Back titration).
Carbazochrome Sodium Sulfonate Hydrate	13.0 ~ 16.0%(0.3 g, Volumetric, Direct titration).	Cefaclor Combination Granules	5.5% or lower(0.3 g, Volumetric, Back titration).
Carumonam Sodium	2.0% or lower(0.2 g, Volumetric, Direct titration).	Cefaclor Fine Granules	1.5% or lower(1 g, Volumetric, Back titration).
Kitasamycin	3.0% or lower(0.1 g, Volumetric, Direct titration).	Cefazolin Sodium	2.5% or lower(1 g, Volumetric, Direct titration).
Kitasamycin Acetate	5.0% or lower(0.1 g, Volumetric, Direct titration).	Cefazolin Sodium for Injection	3.0% or lower(0.5 g, Volumetric, Direct titration).
Kitasamycin Tartrate	3.0% or lower(0.1 g, Volumetric, Direct titration).	Cefatrizine Propylene Glycolate	2.0% or lower(0.5 g, Volumetric, Direct titration).
Quinine Ethyl Carbonate	3.0% or lower(0.5 g, Volumetric, Direct titration).	Cefadroxil	4.2 ~ 6.0%(0.5 g, Volumetric, Direct titration).
Potassium Guaiacolsulfonate	3.0 ~ 4.5%(0.3 g, Volumetric, Direct titration).	Cefadroxil Capsules	7.0% or lower(0.15 g, Volumetric, Direct titration).
Anhydrous Citric Acid	1.0% or lower(2 g, Volumetric, Direct titration).	Cefadroxil for Syrup	3.0% or lower(0.5 g, Volumetric, Direct titration).
Citric Acid Hydrate	7.5 ~ 9.0%(0.5 g, Volumetric, Direct titration).	Cefalexin	8.0% or lower(0.2 g, Volumetric, Back titration).
Potassium Clavulanate	1.5% or lower(5 g, Volumetric, Direct titration).	Cefalexin Capsules	10.0% or lower(0.2 g, Volumetric, Back titration).
Clarithromycin	2.0% or lower(0.5 g, Volumetric, Direct titration).	Cefalexin Combination Granules	5.0% or lower(0.5 g, Volumetric, Direct titration).
Glycerin	13 ~ 17%(0.1 g, Volumetric, Direct titration).	Cefalexin for Syrup	5.0% or lower(0.4 g, Volumetric, Back titration).
Concentrated Glycerin	2.0% or lower(6 g, Volumetric, Direct titration).	Cefalotin Sodium	1.0% or lower(0.5 g, Volumetric, Back titration).
Clindamycin Hydrochloride	6.0% or lower(0.3 g, Volumetric, Direct titration).	Cefixime Hydrate	9.0 ~ 12.0%(0.1 g, Volumetric, Direct titration).
Clindamycin Phosphate	6.0% or lower(0.5 g, Volumetric, Direct titration).	Cefixime Capsules	12.0% or lower(0.1 g, Volumetric, Direct titration).
Cloxacillin Sodium Hydrate	3.0 ~ 4.5%(0.2 g, Volumetric, Direct titration).	Cefodizime Sodium	4.0% or lower(0.5 g, Volumetric, Direct titration).
Clofibrate	0.2% or lower(5 g, Volumetric, Direct titration).	Cefozopran Hydrochloride	2.5% or lower(0.5 g, Volumetric, Direct titration).
Chloramphenicol Sodium Succinate	2.0% or lower(1.0 g, Volumetric, Direct titration).	Cefozopran Hydrochloride for Injection	2.5% or lower(0.5 g, Volumetric, Direct titration).
Chlorobutanol	1.5 ~ 3.0%(0.5 g, Volumetric, Direct titration).	Cefotiam Hydrochloride	7.0% or lower(0.25 g, Volumetric, Direct titration).
Gonadorelin Acetate	8.0% or lower(0.15 g, Volumetric, Direct titration).	Cefotiam Hexetil Hydrochloride	3.5% or lower(0.1 g, Volumetric, Direct titration).
Colchicine	2.0% or lower(0.5 g, Volumetric, Back titration).	Cefotetan	2.5% or lower(1 g, Volumetric, Direct titration).
Cyanamide	1.0% or lower(1 g, Volumetric, Direct titration).	Cefoperazone Sodium	1.0% or lower(3 g, Volumetric, Direct titration).
Ciclacillin	2.0% or lower(1 g, Volumetric, Direct titration).	Cefoperazone Sodium and Sulbactam Sodium for Injection	1.0% or lower(1 g, Volumetric, Direct titration).
Dicloxacillin Sodium Hydrate	3.0 ~ 4.5%(0.1 g, Volumetric, Direct titration).	Cefcapene Pivoxil Hydrochloride Hydrate	2.8 ~ 3.7%(0.5 g, Volumetric, Back titration).
Cyclophosphamide Hydrate	5.5 ~ 7.0%(0.5 g, Volumetric, Direct titration).	Cefcapene Pivoxil Hydrochloride Tablets	3.9% or lower(0.5 g, Volumetric, Back titration).
Distigmine Bromide	1.0% or lower(1 g, Volumetric, Direct titration).	Cefcapene Pivoxil Hydrochloride Fine Granules	1.4% or lower(0.5 g, Volumetric, Back titration).
Dinoprost	0.5% or lower(0.3 g, Volumetric, Direct titration).	Cefditoren Pivoxil	1.5% or lower(0.5 g, Volumetric, Direct titration).
Dihydroergotoxine Mesilate	5.0% or lower(0.2 g, Volumetric, Direct titration).	Cefdinir	2.0% or lower(1 g, Volumetric, Direct titration).
Ciprofloxacin Hydrochloride Hydrate	4.7 ~ 6.7%(0.2 g, Volumetric, Direct titration).	Cefsulodin Sodium	5.0% or lower(1 g, Volumetric, Direct titration).
Sivelestat Sodium Hydrate	12.0 ~ 14.0%(0.2 g, Volumetric, Direct titration).	Ceftazidime Hydrate	13.0 ~ 15.0%(0.1 g, Volumetric, Direct titration).
Isosorbide Dinitrate	1.5% or lower(0.3 g, Volumetric, Direct titration).	Ceftizoxime Sodium	8.5% or lower(0.4 g, Volumetric, Direct titration).
Cilazapril Hydrate	3.5 ~ 5.0%(0.3 g, Volumetric, Direct titration).	Ceftibuten Hydrate	8.0 ~ 13.0%(0.2 g, Volumetric, Direct titration).
Cilastatin Sodium	2.0% or lower(0.5 g, Volumetric, Direct titration).	Cefteram Pivoxil Tablets	4.0% or lower(0.2 g, Volumetric, Direct titration).
Suxamethonium Chloride Hydrate	8.0 ~ 10.0%(0.4 g, Volumetric, Direct titration).	Ceftriaxone Sodium Hydrate	8.0 ~ 11.0%(0.15 g, Volumetric, Direct titration).
Spectinomycin Hydrochloride Hydrate	16.0 ~ 20.0%(0.3 g, Volumetric, Direct titration).	Cefpiramide Sodium	7.0% or lower(0.35 g, Volumetric, Direct titration).
Spectinomycin Hydrochloride for Injection	16.0 ~ 20.0%(0.3 g, Volumetric, Direct titration).	Cefpirome Sulfate	2.5% or lower(0.5 g, Volumetric, Direct titration).

Cefbuperazone Sodium	1.0% or lower (3 g, Volumetric, Direct titration).	Nartograstim for Injection (Genetical Recombination)	3.0% or lower(50 mg, Coulometric)
Cefpodoxime Proxetil	2.5% or lower(0.5 g, Volumetric, Direct titration).	Nicorandil	0.1% or lower(2 g, Volumetric, Direct titration).
Cefminox Sodium Hydrate	18.0 ~ 20.0%(0.1 g, Volumetric, Direct titration).	Bacampicillin Hydrochloride	1.0% or lower(0.5 g, Volumetric, Direct titration).
Cefmetazole Sodium	1.0% or lower(1 g, Volumetric, Direct titration).	Baclofen	1.0% or lower(1 g, Volumetric, Direct titration).
Cefmenoxime Hydrochloride	1.5% or lower(1 g, Volumetric, Direct titration).	Calcium Paraaminosalicylate Hydrate	23.3 ~ 26.3%(0.1 g, Volumetric, Direct titration).
Cefroxadine Hydrate	8.5 ~ 12.0%(0.1 g, Volumetric, Direct titration).	Valaciclovir Hydrochloride	1.7% or lower(0.2 g, Coulometric).
Cefroxadine for Syrup	4.5% or lower(0.1 g, Volumetric, Direct titration).	Valsartan	2.0% or lower(0.1 g, Coulometric).
Cefuroxime Axetil	2.0% or lower(0.4 g, Volumetric, Direct titration).	Paroxetine Hydrochloride Hydrate	2.0 ~ 3.0%(0.2 g, Volumetric, Direct titration).
Sevoflurane	0.2 w/v% or lower(5 mL, Volumetric, Direct titration).	Pancuronium Bromide	8.0% or lower(0.3 g, Volumetric, Direct titration).
Sorbitan Sesquioleate	3.0% or lower(1 g, Volumetric, Direct titration).	Vancomycin Hydrochloride	5.0% or lower(0.1 g, Volumetric, Direct titration).
Zolpidem Tartrate	3.0% or lower(0.5 g, Volumetric, Direct titration).	Vancomycin Hydrochloride for Injection	5.0% or lower(0.1 g, Volumetric, Direct titration).
Tacalcitol Hydrate	3.7 ~ 4.6%(10 mg, Coulometric).	Pantethine	18 ~ 22%(0.2 g, Volumetric, Direct titration).
Tacrolimus Hydrate	1.9 ~ 2.5%(0.5 g, Volumetric, Direct titration).	Pioglitazone Hydrochloride	0.2% or lower(0.5 g, Coulometric).
Tazobactam	0.5% or lower(1 g, Volumetric, Direct titration).	Sodium Picosulfate Hydrate	3.0 ~ 4.5%(0.5 g, Volumetric, Direct titration).
Tazobactam and Piperacillin for Injection	0.6% or lower (Volumetric, Direct titration)	L-Histidine Hydrochloride Hydrate	7.2 ~ 10.0%(0.12 g, Volumetric, Direct titration).
Talampicillin Hydrochloride	3.0% or lower(0.5 g, Volumetric, Direct titration).	Pitavastatin Calcium Hydrate	9.0 ~ 13.0%(0.2 g, Volumetric, Direct titration).
Taltirelin Hydrate	14.0 ~ 15.5%(0.2 g, Volumetric, Direct titration).	Hydroxyzine Pamoate	3.0% or lower(1 g, Volumetric, Direct titration).
Dantrolene Sodium Hydrate	14.5 ~ 17.0%(0.2 g, Volumetric, Direct titration).	Hydrocortisone Sodium Phosphate	5.0% or lower(30 mg, Coulometric).
Berberine Tannate	6.0% or lower(0.7 g, Volumetric, Direct titration).	Pivmecillinam Hydrochloride	1.0% or lower(0.25 g, Coulometric).
Thiamine Chloride Hydrochloride	5.0% or lower(30 mg, Coulometric).	Pivmecillinam Hydrochloride Tablets	3.0% or lower(1 g, Volumetric, Direct titration).
Ticlopidine Hydrochloride	1.0% or lower(0.3 g, Volumetric, Direct titration).	Hypromellose Phthalate	5.0% or lower(1 g, Volumetric, Direct titration).
Timepidium Bromide Hydrate	3.5 ~ 5.0%(0.4 g, Volumetric, Direct titration).	Pipemidic Acid Hydrate	14.5 ~ 16.0%(20 mg, Coulometric).
Tulobuterol	0.2% or lower(2 g, Volumetric, Direct titration).	Piperacillin Hydrate	3.2 ~ 3.8%(0.5 g, Volumetric, Direct titration).
Teicoplanin	15.0% or lower(0.2 g, Volumetric, Direct titration).	Piperacillin Sodium	1.0% or lower(3 g, Volumetric, Direct titration).
Dextromethorphan Hydrobromide Hydrate	4.0 ~ 5.5%(0.2 g, Volumetric, Back titration).	Piperacillin Sodium for Injection	1.0% or lower(3 g, Volumetric, Direct titration).
Deferoxamine Mesilate	2.0% or lower(0.2 g, Volumetric, Direct titration).	Piperazine Phosphate Hydrate	8.0 ~ 9.5%(0.3 g, Volumetric, Direct titration).
Temocapril Hydrochloride	1.0% or lower(0.3 g, Coulometric).	Pimaricin	6.0 ~ 9.0%(0.2 g, Volumetric, Direct titration).
Terbutaline Sulfate	0.5% or lower(1 g, Volumetric, Direct titration).	Pirarubicin	2.0% or lower(0.1 g, Volumetric, Direct titration).
Doxapram Hydrochloride Hydrate	3.5 ~ 4.5%(0.5 g, Volumetric, Direct titration).	Pilsicainide Hydrochloride Hydrate	2.5 ~ 3.3%(50 mg, Coulometric).
Doxycycline Hydrochloride Hydrate	1.4 ~ 2.8%(0.6 g, Volumetric, Direct titration).	Pirenzepine Hydrochloride Hydrate	3.5 ~ 5.0%(0.3 g, Volumetric, Direct titration).
Doxorubicin Hydrochloride	3.0% or lower(0.3 g, Volumetric, Direct titration).	Famotidine for Injection	1.5% or lower(0.1 g, Coulometric).
Doxorubicin Hydrochloride for Injection	4.0% or lower(0.25 g, Volumetric, Direct titration).	Faropenem Sodium Hydrate	12.6 ~ 13.1%(20 mg, Coulometric).
Tosufloxacin Tosilate Hydrate	2.5 ~ 3.5%(30 mg, Coulometric).	Faropenem Sodium for Syrup	1.5 ~ 2.1%(80 mg, Coulometric).
Docetaxel Hydrate	5.0 ~ 7.0%(50 mg, Coulometric).	Fexofenadine Hydrochloride	0.5% or lower(0.25 g, Coulometric).
Todralazine Hydrochloride Hydrate	6.0 ~ 7.5%(0.5 g, Volumetric, Direct titration).	Sodium Fusidate	2.0% or lower(1 g, Volumetric, Direct titration).
Donepezil Hydrochloride	0.2% or lower(0.2 g, Coulometric).	Bupivacaine Hydrochloride Hydrate	4.0 ~ 6.0%(0.25 g, Volumetric, Direct titration).
Tobramycin	11.0% or lower(0.1 g, Volumetric, Direct titration).	Pravastatin Sodium	4.0% or lower(0.5 g, Volumetric, Direct titration).
Trimetazidine Hydrochloride	1.5% or lower(2 g, Volumetric, Direct titration).	Pranlukast Hydrate	1.5 ~ 2.2%(50 mg, Coulometric).
Trimetoquinol Hydrochloride Hydrate	3.5 ~ 5.5%(0.3 g, Volumetric, Direct titration).	Fursultiamine Hydrochloride	5.0% or lower(0.3 g, Volumetric, Direct titration).
Dorzolamide Hydrochloride	0.5% or lower(0.5 g, Coulometric).	Prednisolone Sodium Phosphate	8.0% or lower(0.1 g, Volumetric, Direct titration).
Trehalose Hydrate	9.0 ~ 11.0%(0.1 g, Volumetric, Direct titration).	Procaterol Hydrochloride Hydrate	2.5 ~ 3.3%(0.5 g, Volumetric, Direct titration).
Nabumetone	0.2% or lower(1 g, Volumetric, Direct titration).	Protirelin	5.0% or lower(0.1 g, Volumetric, Direct titration).

Protirelin Tartrate Hydrate	4.5% or lower(0.2 g, Volumetric, Direct titration).
Propylene Glycol	0.5% or lower(2 g, Volumetric, Direct titration).
Flopropione	4.0% or lower(0.5 g, Volumetric, Direct titration).
Flomoxef Sodium	1.5% or lower(0.5 g, Volumetric, Back titration).
Flomoxef Sodium for Injection	1.5% or lower(0.5 g, Volumetric, Back titration).
Betamipron	0.5% or lower(1 g, Volumetric, Direct titration).
Betamethasone Sodium Phosphate	10.0% or lower(0.2 g, Volumetric, Back titration).
Bepotastine Besilate	0.1% or lower(0.3 g, Coulometric).
Pemirolast Potassium	0.5% or lower(0.1 g, Coulometric).
Berberine Chloride Hydrate	8 ~ 12%(0.1 g, Volumetric, Direct titration).
Benzalkonium Chloride	15.0% or lower(Volumetric, Direct titration).
Benzylpenicillin Benzathine Hydrate	5.0 ~ 8.0%(1 g, Volumetric, Direct titration).
Benserazide Hydrochloride	2.5% or lower(0.5 g, Volumetric, Direct titration).
Voglibose	0.2% or lower(0.5 g, Coulometric).
Fosfomycin Calcium Hydrate	12.0% or lower(0.1 g, Volumetric, Direct titration).
Fosfomycin Sodium	3.0% or lower(0.2 g, Volumetric, Direct titration).
Fosfomycin Sodium for Injection	4.0% or lower(0.1 g, Coulometric).
Povidone	5.0% or lower(0.5 g, Volumetric, Direct titration).
Sodium Polystyrene Sulfonate	10.0% or lower(0.2 g, Volumetric, Direct titration).
Polysorbate 80	3.0% or lower(1 g, Volumetric, Direct titration).
Calcium Folate	7.0 ~ 17.0%(0.2 g, Volumetric, Direct titration).
Formoterol Fumarate Hydrate	4.0 ~ 5.0%(0.5 g, Volumetric, Direct titration).
Macrogol 400	1.0% or lower(2 g, Volumetric, Direct titration).
Macrogol 1500	1.0% or lower(2 g, Volumetric, Direct titration).
Macrogol 4000	1.0% or lower(2 g, Volumetric, Direct titration).
Macrogol 6000	1.0% or lower(2 g, Volumetric, Direct titration).
Macrogol 20000	1.0% or lower(2 g, Volumetric, Direct titration).
Micronomicin Sulfate	10.0% or lower(0.2 g, Volumetric, Back titration).
Mizoribine	0.5% or lower(0.5 g, Volumetric, Direct titration).
Mitiglinide Calcium Hydrate	4.5 ~ 6.0%(50 mg, Coulometric).
Minocycline Hydrochloride	4.3 ~ 8.0%(0.3 g, Volumetric, Direct titration).
Minocycline Hydrochloride for Injection	3.0% or lower (Volumetric, Back titration).
Mupirocin Calcium Hydrate	3.0 ~ 4.5%(0.5 g, Volumetric, Direct titration).
Meclofenoxate Hydrochloride	0.50% or lower(1 g, Volumetric, Direct titration).
Mecobalamin	12% or lower(0.1 g, Volumetric, Direct titration).
Metildigoxin	3.0% or lower(0.3 g, Volumetric, Direct titration).
Methyldopa Hydrate	10.0 ~ 13.0%(0.2 g, Volumetric, Direct titration).
Methoxsalen	0.5% or lower(1 g, Volumetric, Direct titration).
Menatetrenone	0.5% or lower(0.5 g, Volumetric, Direct titration).
Mepitiostane	0.7% or lower(0.3 g, Volumetric, Back titration).
Mefloquine Hydrochloride	3.0% or lower(1 g, Volumetric, Direct titration).

Mercaptopurine Hydrate	10.0 ~ 12.0%(0.2 g, Volumetric, Back titration).
Meropenem Hydrate	11.4 ~ 13.4%(0.35 g, Volumetric, Direct titration).
Mosapride Citrate Hydrate	5.0 ~ 6.5%(0.5 g, Volumetric, Back titration).
Morphine Hydrochloride Hydrate	13 ~ 15%(0.1 g, Volumetric, Direct titration).
Morphine Sulfate Hydrate	11.0 ~ 13.0%(0.1 g, Volumetric, Direct titration).
Montelukast Sodium	4.0% or lower(0.3 g, Volumetric, Direct titration).
Ubidecarenone	0.20% or lower(1 g, Volumetric, Direct titration).
Folic Acid	8.5% or lower(10 mg, Coulometric).
Sodium Lauryl Sulfate	5.0% or lower(0.5 g, Volumetric, Direct titration).
Latamoxef Sodium	5.0% or lower(0.5 g, Volumetric, Back titration).
Lansoprazole	0.10% or lower(0.5 g, Coulometric).
Lisinopril Hydrate	8.0 ~ 9.5%(0.3 g, Volumetric, Back titration).
Sodium Risedronate Hydrate	11.9 ~ 13.9%(40 mg, Volumetric, Direct titration).
Limaprost Alfadex	6.0% or lower(0.2 g, Volumetric, Direct titration).
Leuprorelin Acetate	5.0% or lower(0.1 g, Coulometric).
Lincomycin Hydrochloride Hydrate	3.0 ~ 6.0%(0.5 g, Volumetric, Direct titration).
Lenampicillin Hydrochloride	1.5% or lower(1 g, Volumetric, Direct titration).
Levofloxacin Hydrate	2.1 ~ 2.7%(0.5 g, Volumetric, Direct titration).
Roxithromycin	3.0% or lower(0.3 g, Volumetric, Direct titration).
Loxoprofen Sodium Hydrate	11.0 ~ 13.0%(0.2 g, Volumetric, Direct titration).
Rokitamycin	3.0% or lower(0.2 g, Volumetric, Direct titration).
Losartan Potassium	0.5% or lower(0.25 g, Volumetric, Direct titration).

3. Notes to Official Food Additive List (9th ed., 2018)

General Test Method 19: Moisture Content Test (Karl Fischer Method)
The Karl Fischer method is stipulated for the following food additives.

Item	Tolerance
Adipic Acid	0.20% or lower(1g, Direct titration)
L-Arginine L-Glutamate	15.4% or lower(0.3g, Back titration)
Isopropanol	0.20% or lower(10g, Direct titration)
Disodium 5'-Inosinate	29.0% or lower(0.15g, Back titration)
Disodium 5'-Uridylate	26.0% or lower(0.15g, Back titration)
Calcium Disodium Ethylenediaminetetraacetate	13.0% or lower(0.3g, Direct titration)

Sodium o -Phenylphenate	25.0~28.0%(0.1g, Direct titration)
Xylitol	0.50% or lower(1.0g, Direct titration)
Quillaia Extract	6.0% or lower(1.0g, Direct titration)
Citric Acid	Crystals 8.8% or lower(0.2g, Direct titration)
Citric Acid	Anhydride 0.5% or lower(2g, Direct titration)
Disodium Glycyrrhizinate	13.0% or lower(0.2g, Back titration)
Zinc Gluconate	11.6% or lower(0.2g, Direct titration)
Monomagnesium Di-L-Glutamate	24% or lower(0.2g, Direct titration)
Disodium 5'-Cytidylate	26.0% or lower(0.15g, Back titration)
Sucrose Esters of Fatty Acids	4.0% or lower(Back titration)
Sucralose	2.0% or lower(1g, Direct titration)
Sorbic Acid	0.50% or lower(2.0g, Direct titration)
Thiamine Hydrochloride	5.0% or lower(0.50g, Direct titration)
Sodium Dehydroacetate	8.3~10.0%(0.3g, Back titration)
Natamycin	6.0~9.0%(0.03g, Coulometric)
Propylene Glycol	0.20% or lower(10g, Direct titration)
Polyvinylpyrrolidone	6.0% or lower(1g, Direct titration)
Menaquinone(Extract)	0.50% or lower(0.50g, Direct titration)
Chinese Bayberry Extract	8.0% or lower(0.2g, Direct titration)
Yucca Foam Extract	Liquid 60% or lower(0.1g, Direct titration)
Yucca Foam Extract	Powder 8.0% or lower(0.1g, Direct titration)
Folic Acid	8.5% or lower(0.2g, Back titration)
L-Lysine	8.0% or lower(0.20g, Back titration)
D-Ribose	5.0% or lower(1g, Direct titration)
Calcium 5'-Ribonucleotide	23.0% or lower(0.15g, Back titration)
Disodium 5'-Ribonucleotide	27.0% or lower(0.15g, Back titration)
Riboflavin 5'-Phosphate Sodium	10.0% or lower(0.100g, Back titration)
Zinc Sulfate	43.5% or lower(0.1g, Direct titration)

4. Japan Petroleum Institute Standards

Test for water in liquid petroleum products (Karl Fischer Method)

JPI-5S-14-76

5. Japan LPG Association Standards

Moisture Content Test Method in LPG: Karl Fischer Method

JLPGA-S-02-99

6. Japan Agricultural Standards (JAS)

Vegetable Oils (Karl Fischer Method, moisture content 0.2% or lower) (1969)

.....

Q15 | Please provide some examples of the international standards (ISO) and foreign standards that have been adopted for the Karl Fischer titration method.

Listed below are some examples of standards established by the International Organization for Standardization (ISO) and the American Society For Testing and Materials. The BS (U.K.) and DIN (Germany) systems are also based on these standards.

1. General Testing Methods

(1) Volumetric titration

ISO 760-1978

Determination of water - Karl Fischer method (General method)

ASTM E203-01

Water using Karl Fischer reagent

(2) Coulometric titration

ASTM E1064-92

Water in organic liquids by coulometric Karl Fischer titration

2. Individual Standards

ASTM D1364-95

Water in volatile solvents (Fischer reagent titration method)

ASTM D1533-96

Water in insulating liquids (Karl Fischer reaction method)

ASTM D1631-94

Water in phenol and related materials by the iodine reagent method

ASTM D1744-92

Water in liquid petroleum products by Karl Fischer reagent

ASTM D3277-95

Moisture content of oil-impregnated cellulosic insulation

ASTM D3466-85

Water content of trichlorotrifluoroethane

ASTM D3621-84
Water in acetate esters

ASTM D4017-96
Water in paint and paint materials by Karl Fischer method

ASTM D4377-93
Water in crude oils (Karl Fischer) titration

ASTM D7995-19
Standard Test Method for Total Water in Liquid Butane by Liquified Gas Sampler and Coulometric Karl Fischer Titration

ASTM E700-79
Water in gases using Karl Fischer reagent

ISO 2097: 1972
Glycerols for industrial use - Determination of water content - Karl Fischer method

ISO 2514: 1974
Acetaldehyde for industrial use - Determination of water content - Karl Fischer method

ISO 2596: 1994
Iron ores - Determination of hygroscopic moisture in analytical samples - Gravimetric and Karl Fischer methods

ISO 2753: 1973
Urea for industrial use - Determination of water content - Karl Fischer method

ISO 3699: 1976
Anhydrous hydrogen fluoride for industrial use - Determination of water content - Karl Fischer method

ISO 4317: 1991
Surface-active agents and detergents - Determination of water content - Karl Fischer method

ISO 5381: 1983
Starch hydrolysis products - Determination of water content - Karl Fischer method

ISO 5791: 1978
Ammonium nitrate for industrial use - Determination of water content - Karl Fischer method

ISO 6191: 1981
Light olefins for industrial use - Determination of traces of water - Karl Fischer method

ISO 7105: 1985
Liquefied anhydrous ammonia for industrial use - Determination of water content - Karl Fischer method

ISO 7335: 1987
Iron ores - Determination of combined water content - Karl Fischer method

ISO 10101-1-3: 1993
Natural gas - Determination of water by the Karl Fischer method -
Part 1: Introduction
Part 2: Titration procedure
Part 3: Coulometric titration

ISO 10362-2: 1994
Cigarettes - Determination of water in smoke condensates - part 2: Karl Fischer method

ISO 11817: 1994
Roasted ground coffee - Determination of moisture content - Karl Fischer method

.....

Q16 | What reference works are there concerning Karl Fischer measurement methods?

The following is a list of basic references concerning Karl Fischer titration. It consists mainly of works written by members of the Mitsubishi Chemical Corporation research team.

1. Mitchell & Smith: Aquametry, 2nd Edition, Part 3 (1980).
2. Funasaka, W., Muroi, M., Suibun no Teiryō [Measuring Moisture Content] II: Karl Fischer Method (out of print).
Bunseki Raiburari 14 [Analysis Library 14], published by Tokyo Kagaku Dojin(1969).
3. General Introductions
Muroi, K., "Karu Fisssha Ho ni Yoru Suibun no Sokuteiho" [Measuring Moisture Content Using the Karl Fischer Method] (in Keisoku Gijutsu [Measurement Technology], 3, 49, 1977).
Muroi, K., "Bunseki Kagaku ni Okeru Mizu" [Water in Chemical Analysis], (in Bunseki [Analysis] 2, 74, 1979).
4. Papers Concerning Pyridine-Free Types Kato, H., Ono, M., Kuwata, S.:
(1) "New Karl Fischer Volumetric Reagent Composed of a Base" (in Bunseki Kagaku 35, 91, 1986).
(2) "Determination of Moisture by Karl Fischer Coulometric Reagent Composed of New Bases" (in Bunseki Kagaku 33, 638, 1984).
(3) "Determination of Moisture in Ketones and Lower Carboxylic Acids by New Karl Fischer Coulometric Reagent"(in Bunseki Kagaku 34, 147, 1985).

- (4) "Determination of Moisture in Amines by New Karl Fischer Coulometric Titration"
(in Bunseki Kagaku 34, 805, 1985).

Memo "Outline of official testing methods in other countries"

ISO: The International Organization for Standardization (ISO) was established to promote the discussion and adoption of global standards with a view to facilitating the international exchange of goods and services and to developing cooperation in the spheres of intellectual, scientific, technological and economic activity. Formally established in 1947, ISO has its headquarters in Geneva, Switzerland. JIS is currently reviewing its standards with the aim of making them compatible with these international standards.

ASTM: The American Society For Testing Materials (ASTM) is an American organization dedicated to science and technology. It was formed in 1898 to standardize specifications and test methods, etc., for industrial materials. It has published numerous ASTM standards which include testing methods.

B S : British Standards (BS) are standards established by the British Standards Institution, which was founded in 1901.

DIN: Industrie Normen (DIN) are standards established by the Deutsches Institut für Normung, which was renamed in 1975 to match the name of the standards.

6. Important Information about Handling and Using Karl Fischer Reagents

Q17 | Karl Fischer titration is classed as an official testing method. What Japanese standards have been adopted?

In addition to handling requirements related to the characteristics of Karl Fischer reagents, there are precautions to be taken in relation to safety and hygiene. It is important to fully understand both sets of requirements.

1. Safety and Hygiene Requirements

- 1) Never drink the reagent or inhale its vapor.
- 2) Avoid skin contact. If the reagent does come in contact with the skin, wash it off with soap, etc., and rinse well with water.
- 3) If reagent splashes into an eye, flush the eye immediately with water, for at least 15 minutes. The eye should be checked by an eye specialist.
- 4) Make sure that the room is adequately ventilated when handling Karl Fischer reagents.
- 5) Keep the reagents away from naked flames.
- 6) Observe general rules for handling reagents, including the following.
 - Organic Solvent Poisoning Prevention Regulations Injury Prevention Rules For Specified Chemical Substances, etc.
 - Poisonous and Deleterious Substances Control Law Fire Prevention Law (hazardous substances)

The regulations vary according to the specific type of reagent. For detailed information, contact the Mitsubishi Chemical Corporation.

2. Handling Requirements

(1) General Requirements

- a) Sampling bottles and other equipment must be dried thoroughly before use. During testing, take care to prevent contamination by atmospheric moisture. The following paper includes detailed information about the prevention of moisture contamination.

Muroi, M., "Measuring Trace Moisture Content Using the Karl Fischer Method - With Particular Emphasis on the Influence of Atmospheric Moisture and the Prevention Thereof" (in Bunseki Kagaku 12, 858, 1963)

- b) Check to find out if the sample will cause an interference reaction. If the sample is one where the interference reaction can be prevented, take the appropriate steps to do so.

- c) Store Karl Fischer reagents at or below room temperature and in a location that is not exposed to the light. Seal bottles to prevent the absorption of moisture.

(2) Volumetric Reagents

- a) Refer to the relevant sections for information about points that require particular care during volumetric titration, such as changes over time in the titer of Karl Fischer Reagent SS-Z (or SS), the titer of standard watermethanol and the evaluation procedures.
- b) Avoid the following combination when using volumetric reagents;
- Karl Fischer Reagent SS and Dehydrating Solvent KTX
 - Karl Fischer Reagent SS-Z and Dehydrating Solvent CP

(3) Coulometric Titration

- a) The analytical capability of Aquamicon AX and AS anolytes is approximately 800-1,000mgH₂O per 100ml of anolyte. However, if a sample is added in stages so that the total amount exceeds 150ml, the sample will have an effect that causes a gradual decline in current efficiency. This may lead to inaccurate results. In such cases, discard all the reagent and begin again with fresh reagent.
- b) The analytical capability of Aquamicon CXU catholyte is approximately 130-150mgH₂O per 5ml of catholyte. With prolonged use, however, the reagent will gradually turn light brown and then dark brown. If the color begins to change, the reagent should be completely removed, with a pipette, etc., and replaced with fresh reagent. Do not add fresh reagent to discolored reagent.

Chapter II: Applications - 1

Chapter II: Basic Knowledge

This section is a summary of technical knowledge accumulated by Mitsubishi Chemical Corporation over many years. This information is included as a guide for those actually using Karl Fischer titration to measure the moisture content of individual compounds. There are specific examples for both organic and inorganic compounds.

II-1. Organic Compounds

Karl Fischer titration is the ideal method for measuring the moisture content of organic compounds. With very few exceptions, it is suitable for almost all compounds. Measurement is straightforward, as organic compounds can generally be dissolved in the solvents used with Karl Fischer reagents.

The section of Basic Knowledge gave an overview of the range of applications, grouped into those that can be measured directly, those that cause interference but which can be measured after modification, and those that cause interference. Refer to the relevant parts of the manual for essential information on the reactive functional groups that cause interference.

In the Section on Applications, we will describe specific Karl Fischer titration methods for individual compounds, together with examples that illustrate key factors to be taken into account when actually using these methods. Of course, it is impossible to cover every type of substance, so users should refer to the examples for similar compounds when establishing the conditions for moisture measurements.

Important!

Some of the examples refer to earlier reagent products. The latest products are those named as the "reagents to use". There may be exceptional cases in which measurements cannot be carried out as shown in the tables. Users should choose the most appropriate type of reagent and measurement method.

1. Hydrocarbons

Key Points

Hydrocarbons can be measured readily using standard procedures.

Both volumetric and coulometric titration can be used. Moisture content tends to be very low, however, because of the low water solubility of hydrocarbons and because of their low water absorption capacity. For this reason, coulometric titration is suitable.

In the case of volumetric titration, standard dehydrated solvents are used. Solubility may be inadequate with long-chain hydrocarbons, but moisture content can be measured through dispersal extraction after sufficient stirring. Dehydrated solvents formulated for use with oils can be used to enhance solubility with good effect.

Substances with low moisture content can be measured accurately using Karl Fischer Reagent SS-Z (or SS) with a low titer.

With coulometric titration, the sample is added directly to the electrolyte solution (anolyte). Measurement is carried out after dissolution or dispersal.

In the case of olefins, double bonding may cause interference. using the electrolyte solution (anolyte), the interference can be lowered.

Examples of substances that can be measured directly:

Ethylene, propylene, butadiene, propane, butane (see the discussion on industrial LPG in Chapter III: Applications 2, III-1).

Pentane, 2,4-dimethyl pentane, 2,2-methyl pentane, 2,2,4-trimethyl pentane, octane, 3-methylhexane, decane, octadecane, 2-pentene, dipentene, 1,3-pentadiene, isooctane, cyclopentane, methyl cyclopentane, cyclohexane, methyl cyclohexane, cyclohexene, benzene, toluene, xylene, ethyl benzene, mesitylene, styrene, naphthalene, diphenyl, decalin, hexamethyl benzene, anthracene, phenanthrene

[Examples of Measurement]

(1) Volumetric titration

Reagents used: Karl Fischer Reagent SS-Z (or SS)

General-use Dehydrated Solvent GEX (or MS) 25-50ml

Substance	Dehydrated solvent	Sample quantity(g)	Measurement value(mg)	Moisture content(ppm)
n-Hexane	General-use	6.5870	0.25	38
Benzene	"	8.7206	0.78	89
Toluene	"	8.5511	0.45	53
Xylene	"	4.3511	0.72	165

(2) Coulometric titration

Reagents used: Aquamicon AX (or AS)

100ml

Aquamicon CXU 5ml

Substance	Sample quantity(g)	Measurement value(μ g)	Moisture content(ppm)
n-Pentane	2.5775	48	19
n-Hexane	1.8828	37	20
Isooctane	3.4600	89	26
n-Decane	2.0480	54	26
n-Dodecane	2.1048	63	30
Ligroin	2.1315	124	58
Cyclohexene	2.2335	69	31
1-Hexene	0.7600	54	71
1-Decene	0.7475	30	40
1-Tetradecene	1.5460	21	14
Benzene	2.5297	334	132
Toluene	2.5151	380	151
Xylene	2.4930	174	70
Naphthalene	1.7755	129	73

All liquid samples can be measured continuously up to 20-50ml, using approximately the same amounts as shown in the table.

Note: It is convenient to use a syringe-type sampling bottle for naphthalene. Refer to JIS K2436 for details of the test method.

2. Halogenated Hydrocarbons

Key Points

The behavior of halogenated hydrocarbons is similar to that of hydrocarbons. Measurements can be carried out using standard procedures without problems.

Both volumetric and coulometric titration can be used, but coulometric titration is recommended because of the minute amounts of moisture included in these substances.

In the case of volumetric titration, standard dehydrated solvents are used. Halogenated hydrocarbons dissolve well in methanol, but solubility may become inadequate if the substance is added continuously. With sufficient stirring, however, it will be possible to extract and measure the moisture content. An effective way of enhancing solubility is to use dehydrated solvents formulated for use with oils.

Substances with low moisture content can be measured accurately using Karl Fischer Reagent SS-Z (or SS) with a low titer.

For coulometric titration, the sample is added directly to the electrolyte solution (anolyte). Measurement is carried out after dissolution or dispersal.

There is no interference, even in the case of substances such as vinyl chloride, with double bonding. Direct titration can be used in the same way.

Because of the processes used in their production, halogenated hydrocarbons sometimes contain trace amounts of free chlorine. This causes interference through the oxidation of iodide ions to produce free iodine. As a result, the moisture measured will be reduced in proportion to the amount of free iodine. This can be prevented by using Dehydrated Solvent MS as the titration solvent, and by agitating the solution thoroughly before the Karl Fischer titration, to render the free chlorine inactive. This is because of the reaction between amine and sulfur dioxide in the dehydrated solvent, as shown in the following formula.

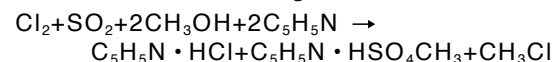

Reference: Muroi, M., *Bunseki Kagaku* 16, 1061 (1967)
"Determination of Water in Substances Containing Active Chlorine by Karl Fischer Titration"

Examples of substances that can be measured directly:

Methyl chloride, vinyl chloride, methylene chloride, methylene iodide, chloroform, carbon tetrachloride, iodoform, ethyl iodide, ethylene bromide, ethylidene bromide, 6-chloropropylene, 1,4-dichloro-2-butene, bromobenzene, iodobenzene, chloronaphthalene, bromonaphthalene

[Examples of Measurement]

(1) Volumetric titration

Reagents used: Karl Fischer Reagent SS-Z (or SS)
General-use Dehydrated Solvent GEX (or MS) 25-50ml

Substance	Dehydrated solvent	Sample quantity (g)	Measurement value (mg)	Moisture content (ppm)
Chloroform	General-use	14.4999	1.60	110
Carbon Tetrachloride		15.7825	0.49	31
1,2-Dichloroethane	"	6.1605	1.48	240
1,1,2-Trichloroethane	"	14.0776	0.74	53
Chlorobenzene	"	10.9400	0.71	65

(2) Coulometric titration

Reagents used: Aquamicon AX (or AS) 100ml
Aquamicon CXU 5ml

Substance	Sample quantity (g)	Measurement value (µg)	Moisture content (ppm)
Methylene chloride	3.7445	62	17
Ethylene chloride	3.5193	244	70
Chloroform	4.1721	332	80
1,1,1-Trichloroethane	3.7146	380	102
1,1,2,2-Tetrachloroethane	7.9300	3553	430
Carbon tetrachloride	4.4559	101	22
Chlorobenzene	3.1038	207	67
Methylene bromide	2.4660	715	290
Ethylene bromide	2.2125	202	91
Bromoform	2.6518	1747	659
1-Bromotetradecane	2.0400	168	75
1-Bromohexadecane	1.0255	52	51
Tetrabromoethane	2.9079	478	164
Methyl iodide	2.3104	476	206
Ethy iodide	1.9392	337	174
Hexadecyl bromide	1.0067	50	50

3. Alcohols

Key Points

The moisture content of alcohols can be measured easily using direct titration. End-points are stable and highly accurate analytical results are attainable. Both volumetric and coulometric titration can be used.

In the case of volumetric titration, the sample is dissolved in a general-use dehydrated solvent and titrated. Alcohols dissolve very well in this type of solvent and there should not be any problems. Solubility may be inadequate with higher alcohols (such as stearyl alcohol). In such cases it is appropriate to use dehydrated solvents formulated for use with oils.

Propargyl alcohol interferes with the titration by reacting with the Karl Fischer reagent.

For coulometric titration, the sample is dissolved in the electrolyte solution (anolyte). Titration will be prolonged if samples have a high moisture content (2% or above). We recommend either the reduction of the sample quantity, or the use of volumetric titration.

Examples of substances that can be measured directly:

-Monohydric alcohols-

Methanol, ethanol, isopropanol, alkyl alcohol, n-, iso-, tert-butanol, isoamyl alcohol, 2-methyl-4-butanol, 2,4-dimethyl-3-pentanol, decanol, dodecanol, octadecanol, geraniol, citronellol, cyclohexanol, borneol, terpinenol, benzyl alcohol, cholesterol

-Polyhydric alcohols-

Ethylene glycol, 1,2-propanediol, 1,3-propanediol, glycerine, 1,4-butanediol, 1,4-butanediol, 2-methyl-1, 3-propanediol, diethylene glycol, pentaerythritol, D-mannitol, D-sorbitol

[Examples of Measurement]

(1) Volumetric titration

Reagents used: Karl Fischer Reagent SS-Z (or SS)

General-use Dehydrated Solvent GEX (or MS) 25-50ml

Substance	Dehydrated solvent	Sample quantity (g)	Measurement value (mg)	Moisture content (ppm)
Methanol	General-use	3.8240	0.43	112
Ethanol	"	2.2102	3.33	1507
n-Butanol	"	3.9210	0.49	125
Ethylene glycol	"	5.5002	0.46	84
Propylene glycol	"	5.1726	0.78	151
Diphenyl carbinol	"	0.5953	0.33	554

Samples can be measured continuously up to 20-50ml using approximately the same quantities as those shown in the table.

(2) Coulometric titration

Reagents used: Aquamicon AX (or AS)

100ml

Aquamicon CXU

5ml

Substance	Sample quantity (g)	Measurement value (µg)	Moisture content (ppm)
Ethanol	2.1936	3026	1379
n-Propanol	2.2488	1291	574
i-Propanol	2.2244	590	265
i-Butanol	2.2361	1043	467
tert-Butanol	2.1829	1315	602
n-Amyl alcohol	4.1200	3024	722
Benzyl alcohol	2.9511	280	95
Ethylene glycol	3.1536	539	171
Propylene glycol	2.9381	1212	412
Ethylene glycol monoethyl ether	2.6777	639	239
2-Ethyl hexanol	0.8310	282	339
Undecanol	0.8240	63	76
Glycerin	0.7572	930	1228

Samples can be measured continuously up to 20-50ml using approximately the same quantities as those shown in the table.

4. Ethers

Key Points

The moisture content of ethers can be measured readily using direct titration. End-points are stable and highly accurate analytical results are obtainable. The behavior of ethers is similar to that of hydrocarbons.

Both volumetric and coulometric titration can be used.

With volumetric titration, the sample is dissolved in a general-use dehydrated solvent and measured. Solubility may be inadequate with ethers that have a high carbon number. In such cases we recommend the use of dehydrated solvents formulated for use with oils.

In the ether group, the following compounds need special care: Substances that have double bonding and cause interference - Vinyl ether (Note 1)

For coulometric titration, add the sample to the electrolyte solution (anolyte) and take the measurement. With most ethers, measurement can be carried out without difficulty. With propylene oxide, however, there is a limit to the quantity of sample that can be added (Note 2).

Examples of substances that can be measured directly:

Dimethyl ether, diethyl ether, isopropyl ether, ethylene oxide, tetramethylene oxide, methyl carbitol, diethylene glycol, ethylene glycol dimethyl ether, diphenyl ether, dioxane, tetrahydrofuran

[Examples of Measurement]

(1) Volumetric titration

Reagents used: Karl Fischer Reagent SS-Z (or SS)

General-use Dehydrated Solvent GEX (or MS) 25-50ml

Substance	Dehydrated solvent	Sample quantity (g)	Measurement value (mg)	Moisture content (ppm)
γ-Butyrolactam	General-use	5.6364	1.18	209
Dioxane	"	4.9618	1.13	228
Tetrahydrofuran	"	2.4548	2.96	1206
Propylene oxide	"	4.3472	3.09	711
Ethyl vinyl ether	"	0.1833	0.59	3200
n-Butyl vinyl ether	"	0.1657	0.10	600
2,3-Dihydrofuran	"	0.2647	0.65	2400

(2) Coulometric titration

Reagents used: Aquamicon AX (or AS)

100ml

Aquamicon CXU

5ml

Substance	Sample quantity (g)	Measurement value (μg)	Moisture content (ppm)
Isopropyl ether	2.0613	430	208
Ethylene glycol monoethyl ether	2.7175	653	240
Diethylene glycol Monoethyl ether	2.8298	1094	387
Diethylene glycol Ethyl ether	4.5130	3961	878
Dioxane	2.9090	120	41
Tetrahydrofuran	0.8278	923	1115
γ-Butyrolactam	3.1256	507	162
2-Methyl tetrahydrofuran	4.3290	944	218
Propylene oxide	1.7117	1217	711

Note 1:

Vinyl ether causes interference by reacting with the Karl Fischer reagent to produce iodoacetal in accordance with the following formula.

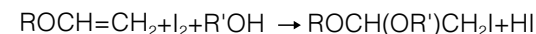

The same type of interference occurs with 2,3-dihydrofuran and dihydropyran.

Corrected titration method:

Add a small amount of the sample (0.5g or less) to 50ml of Dehydrated Solvent CP and titrate this with Karl Fischer reagent. If the amount added is greater than 0.5g, an interference reaction will gradually occur.

Note 2:

It proved possible to add propylene oxide in three amounts of 1.7g (total: 5.1g). Thereafter the analytical readings rose until finally, an end point was not reached.

With volumetric titration, it proved possible to add 50g and measure this directly without any problems.

5. Phenols**Key Points**

With most phenols the moisture content can be measured directly. As a general rule there are no limitations with volumetric titration, but it is important to be aware that limitations do exist in the case of coulometric titration.

With volumetric titration, the sample is dissolved in a general-use dehydrated solvent in the same way as for alcohols, before undergoing Karl Fischer titration. Solubility is not a problem.

Aminophenols cannot be measured in methanol because of interference reactions. Measurements can be taken, however, by using a titration solvent prepared by adding salicylic acid to Dehydrated Solvent MS (see "12. Amines"). The size of the sample used in such cases should not exceed 2g.

In the case of coulometric titration, anodic oxidation produces a precipitate that adheres to the anode. The resulting contamination of the electrode precludes normal electrode performance and reduces the efficiency of the current. An end point cannot be reached with hydroquinone and aminophenols. This kind of interference is common with coulometric titration, and care should be taken when using the method. In tests carried out by Mitsubishi Chemical Corporation, however, measurements have proved possible under controlled conditions, as follows.

To 100ml of Aquamicron AX,

- approximately 1g of phenol is added to begin with.
- The total cumulative quantity added is approximately 5g. If there is too much phenol the efficiency of the current will decline and gradually lead to higher analytical values.

Examples of substances that can be measured directly:

Phenol, catechol, resorcinol, pyrogallol, guaiacol, picric acid, o-cresol, p-cresol, 5-methyl resorcinol, eugenol, p-tert-butyl catechol, α -naphthol, β -naphthol

[Examples of Measurement]**(1) Volumetric titration**

Reagents used: Karl Fischer Reagent SS-Z (or SS) 25-50ml
General-use Dehydrated Solvent GEX (or MS)

Substance	Dehydrated solvent	Sample quantity (g)	Measurement value (mg)	Moisture content (%)
Phenol	General-use	1.9139	1.94	0.101
m-Cresol	"	2.6048	1.92	0.074

(2) Coulometric titration

Reagents used: Aquamicron AX (or AS) 100ml
Aquamicron CXU 5ml

Substance	Sample quantity (g)	Measurement value (μ g)	Moisture content
Phenol	1.8906	1241	656 ppm
m-Cresol	2.0319	242	119 ppm
o-Cresol	0.6042	3048	0.504%
2,6-Xylenol	1.4616	1737	0.119%

6. Ketones

Key Points

If the Karl Fischer reagent and the titration solvent contain methanol, ketones react with the methanol (ketal bonding) as shown in the following formula. As it produces water this causes an interference reaction.



This may increase the time needed to reach the end point, or may mean that it is never reached. Excessively high moisture readings are among other phenomena that can adversely affect accuracy and precision.

However, Karl Fischer titration can be carried out if the following counteracting steps are taken.

- Use a Karl Fischer reagent and titration solvent that do not contain methanol.
- The degree of interference varies according to the type of ketone compound. Determine the size of the sample to use with reference to the specific type of compound.

In general, acetone and cyclohexanone show the strongest reactivity among the aliphatic ketone compounds and reactivity decreases in proportion to the carbon number. Aromatic ketone compounds are reported to be less reactive than the aliphatics. Either volumetric or coulometric titration can be used with these ketones, but a reagent formulated for ketones should be chosen.

Karl Fischer Reagent SS-Z (or SS) is used for volumetric titration. It contains absolutely no methanol and can be used safely with ketones. Use Dehydrated Solvent KTX (or CP), which is formulated for ketones. For coulometric titration, use a combination of Aquamicon AKX/CXU.

- Reference:** (1) Reference: Muroi, M, et al., J. Japan Petrol. Inst., 26, 97 (1983). "Determination of Water in Ketones and Silicone Oils by Karl Fischer Titration Method"
- (2) Kato, H.: "Determination of Moisture in Ketones and Lower Carboxylic Acids by New Karl Fischer Coulometric Reagent" (in Bunseki Kagaku 34, 147, 1984).

Examples of substances that can be measured directly:

The following inactive carbonyl compounds can be added to methanol (Dehydration Solvent GEX, MS) and measured directly.

Di-isopropyl ketone, camphor, benzophenone, deoxybenzoin, benzyl, benzoin, alizarin, quinalizarin, ninhydrin

For other substances, use a ketone-type reagent.

[Examples of Measurement]

(1) Volumetric titration

Reagents used: Karl Fischer Reagent SS-Z (or SS)
Ketone-type Dehydrated Solvent KTX (or CP, PP) 25-50ml

Substance	Dehydrated solvent	Sample quantity (g)	Measurement value (mg)	Moisture content (%)
Acetone	Ketone-type	1.4616	3.31	0.23
Acetylacetone	"	1.8327	1.46	0.080
Methyl ethyl ketone	"	2.2490	1.13	0.050
Methyl isobutyl ketone	"	2.2779	0.44	0.019
Cyclohexanone	"	0.8839	0.80	0.090
Acetophenone	"	2.0562	3.58	0.17
Furfural	"	0.5799	5.94	1.02
Diacetone alcohol	"	1.8455	3.33	0.18

Note: Dehydrated Solvent KTX should be used in combination with Karl Fischer Reagent SS-Z, and Dehydrated Solvents CP and PP with Karl Fischer Reagent SS.

A feature of Dehydrated Solvents KTX and CP is that they can be used to take measurements at normal temperatures. This is particularly convenient as interference can be suppressed and measurements made without regulating the reaction temperature.

Dehydrated Solvent KTX must always be used with a pyridine-free Karl Fischer Reagent SS-Z. A normal end point will not be achieved if Karl Fischer Reagent SS is used.

In general, the interference state of ketones is ascertained through the continuous addition of reagent. When the analytical reading begins to appear abnormally high, it should be assumed that interference has begun. Beyond that point, analytical readings must be discarded.

(2) Coulometric titration

Reagents used: Aquamicon AKX
Aquamicon CXU

100ml
5ml

Substance	Sample quantity (g)	Measurement value (µg)	Moisture Content (%)	Measurable amount (ml)
Acetone	0.3954	907	0.229	10
Methyl ethyl ketone	0.4141	464	0.112	15
Methyl isobutyl ketone	0.8010	102	127ppm	15
Acetylacetone	0.9760	683	0.700	15
Acetophenone	0.5451	215	394ppm	15
Cyclopentanone	0.4955	1090	0.220	
Cyclohexanone	0.3117	635	0.204	5
Diacetone alcohol	0.9602	217	226ppm	
2-Methoxy-2-methyl-4-pentanone	1.8963	81	43ppm	2

It is important to be aware of patterns of blank current (also described as "background" or "drift" current) in the moisture meter. If a gradual rise in the blank current causes the end point to fluctuate, it will not be possible to obtain accurate analytical results. In such cases the electrolyte must be replaced.

7. Aldehydes**Key Points**

If the Karl Fischer reagent and the titration solvent contain methanol, aldehydes react with the methanol (acetal bonding) as shown in the following formula. As it produces water, this causes an interference reaction.

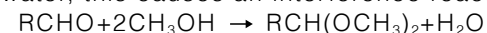

This may cause end point fluctuation, or may mean that the end point is never reached. Other phenomena include excessively high moisture readings.

As shown in the following formula, aldehydes may also react with an ingredient in the Karl Fischer reagent (sulfur dioxide), causing an interference reaction that consumes water (bisulfite addition) and reduces the moisture content reading.

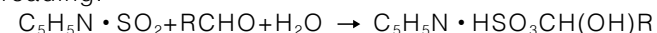

Furthermore, since aldehydes are more reactive than ketones, the reaction speed will vary considerably according to the specific aldehyde involved. Because of these complex problems it is very difficult to obtain accurate analytical readings for aldehydes.

In general, Karl Fischer titration can be carried out if the following counteracting steps are taken.

- Use a Karl Fischer reagent and titration solvent that do not contain methanol.
- Keep the size of the sample used for titration to a minimum to suppress the reaction that consumes water.
- Acetaldehydes are highly reactive and must be titrated under special conditions. These are described later in this manual.

With coulometric titration, sulfur dioxide in the electrolytic solution causes interference that leads to low moisture readings. Although an end point may be reached the analytical reading is unlikely to be accurate and using this method is difficult. In practice, this method should never be used with acetaldehydes.

Reference: Muroi, K, et al., Bull. Chem. Soc. Japan, 38,1176 (1965).
"The Determination of the Water Content in Acetaldehyde by Means of Karl Fische Reagent"

Examples of substances that can be measured directly:

The following inactive carbonyl compounds can be dissolved in a general-use dehydrated solvent and measured directly.

Formaldehyde, chloral However, these substances tend to react with methanol at room temperature (above 25°C) and we recommend a titration method whereby the sample is dissolved in a ketone-type dehydrated solvent.

[Examples of Measurement]**(1) Volumetric titration**

Reagents used: Karl Fischer Reagent SS-Z (or SS)
Dehydrated Solvent KTX (or CP) 25-50ml

Substance	Dehydrated solvents	Sample Quantity (g)	Measurement Value (mg)	Moisture Content (%)
n-Butyraldehyde	Ketone-type	0.4020	3.56	0.886
Isobutyraldehyde	"	0.3952	0.96	0.243
Crotonaldehyde	"	0.4239	0.67	0.158
Propionaldehyde	"	0.2014	7.36	3.65
Formalin	General-use	0.0328	17.42	53.1
Chloral hydrate	"	0.1752	19.27	11.0

Note: Dehydrated Solvent KTX should be used in combination with Karl Fischer Reagent SS-Z, and Dehydrated Solvent CP with Karl Fischer Reagent SS.

Measuring moisture content in acetaldehydes

Given the intensity of the interference reaction that occurs with acetaldehydes, Dehydrated Solvent PP should be used as it contains no pyridine-sulfur dioxide. The following guidelines should apply.

If the acetaldehyde has a high moisture content, 0.2ml samples can be measured. If the moisture content is less than about 0.2%, however, the sample will be too small and this method cannot be used. Accordingly, when measuring trace amounts of moisture, 5-10ml of sample should be added to 5ml of Dehydrated Solvent PP in the apparatus shown in the diagram. The sample should be vaporized using dried nitrogen during the titration.

1) Sampling

Attach a piece of silicon rubber to the needle of a carefully dried syringe (capacity: 5-10ml, needle length: approx. 10cm). Place the syringe in a dry polyethylene bag and store it in a refrigerator. Remove the thoroughly chilled syringe from the refrigerator, together with a sample container (fitted with a metal sampling stopper) that has also been stored in the refrigerator. Insert the needle of the syringe into the metal stopper and extract some of the sample. Flush the syringe twice with the sample. On the third occasion, extract 5-10ml of sample.

2) Titration

Pour 5ml of Dehydrated Solvent PP into a titration flask (capacity: approx. 50ml), as shown in the diagram. Place the flask in a water bath at a temperature of 20-25°C. Add dried nitrogen to the titration flask through a three-way cock (E) at a rate of approximately 0.9l/min. Titrate with Karl Fischer Reagent SS until the end point is reached. Stop the agitation of the Dehydrated Solvent PP and the nitrogen flow. Insert the syringe through one of the holes in the three-way valve (E) until the tip of the needle reaches the surface of the Dehydrated Solvent PP. Inject the sample immediately. Start the agitation of the Dehydrated Solvent PP and the nitrogen flow. At the same time, titrate to the end point, using Karl Fischer Reagent SS to drive off the vaporized acetaldehyde.

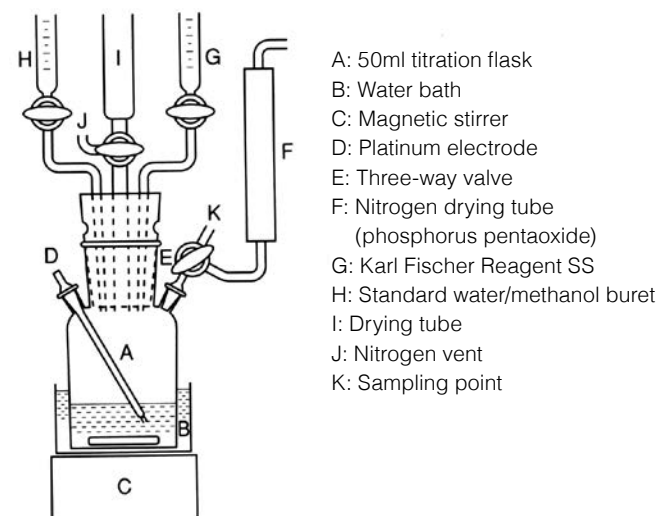

Figure 19: Acetaldehyde Moisture Titration System

Examples:

No	Sample amount (ml)	Measurement (ml)	Measurement(mg)	
			(mg)	(%)
1	1	0.14	0.42	0.053
2	3	0.41	1.23	0.052
3	5	0.65	1.95	0.050
4	7	1.06	3.17	0.057
5	10	1.32	3.95	0.050

Note: Titer of Karl Fischer reagent: 3.00mg/ml

(2) Coulometric titration

Reagents used: Aquamicron AKX 100ml
 Aquamicron CXU 5ml

Substance	Sample quantity (g)	Measurement value (µg)	Moisture Content (%)
Benzaldehyde	0.5205	343	660ppm
Salicylaldehyde	0.6257	751	0.120
3-Phenylpropionaldehyde	0.5435	1467	0.270
Chloral hydrate	0.0441	4916	11.1

8. Organic Acids**Key Points**

With most organic acids, moisture content can be measured directly and easily. If a dehydrated solvent with methanol as its main ingredient is used, however, interference will occur as the result of an esterification reaction between methanol and lower carboxylic acids such as formic acid, acetic acid and adipic acid. These reactions produce water and will be evidenced by a delayed end point or an unusually high analytical result.

Esterification reactions vary, depending on the individual acid. Formic acid shows a strong esterification reaction and will react very quickly with methanol. Reactivity lessens as the carbon number increases.

Normally, during volumetric titration, propionic acid will not trigger interference attributable to an esterification reaction. Aromatic carboxylic acid is another substance that does not cause interference related to esterification.

Interference can also result from a reaction with iodine. Formic acid appears to be affected by the oxidation of iodine and L-ascorbic acid reacts quantitatively with Karl Fischer reagent.

For volumetric titration, a ketone-type dehydrated solvent is used with lower carboxylic acids. A general-use dehydrated solvent can be used with higher carboxylic acids and aromatic carboxylic acid. If problems are encountered with the methanol solubility of substances with high carbon numbers, a dehydrated solvent formulated for oils (such as stearic acid) should be used.

For measurements based on coulometric titration, a ketone-type of anolyte is used with the lower carboxylic acids. Coulometric titration cannot be used for formic acid, however, as an end point cannot be reached. A general-use electrolyte can be used with higher carboxylic acids and aromatic carboxylic acid.

Examples of substances that can be measured directly:

Acetic acid, mono-, di-, trichloroacetic acid, trifluoroacetic acid, propionic acid, acrylic acid, methacrylic acid, trimethylacetic acid, caproic acid, stearic acid, oleic acid, linolenic acid, cyclohexane carboxylic acid, cyclohexyl acetic acid, camphoric acid, abietic acid, 3,5-dinitrobenzoic acid, cinnamic acid, anisic acid, benzilic acid, 2,4-dichlorophenoxy acetic acid, benzoic acid

Polybasic acids

Oxalic acid, malonic acid, maleic acid, succinic acid, diglycolic acid, adipic acid, sebacic acid, nitrilotriacetic acid, phthalic acid, terephthalic acid

Sulfonic acids

Benzenesulfonic acid, toluenesulfonic acid, xylenesulfonic acid, naphthalenesulfonic acid, sulfanilic acid

Hydroxy acids

Glycolic acid, α -hydroxybutyric acid, citric acid, tartaric acid, δ -hydroxycaproic acid, α -hydroxyadipic acid, α,α -dihydroxyadipic acid, ricinoleic acid, salicylic acid

Amino acids

Glycine, leucine, sarcosine, valine, aspartic acid, iminodiacetic acid, creatine, asparagine, methionine, phenylalanine, glutamic acid

[Examples of Measurement]**(1) Volumetric titration**

Reagents used: used:Karl Fischer Reagent SS-Z (or SS)
Dehydrated Solvent KTX (or CP) 25-50ml
Dehydrated Solvent OL II (or CM)

Substance	Dehydrated solvents	Sample quantity (g)	Measurement value (mg)	Moisture content (%)
Acetic acid	Ketone-type	4.8365	7.86	0.16
Monochloroacetic acid	"	1.0110	2.70	0.27
Dichloroacetic acid	"	0.7817	0.86	0.11
Propionic acid	General-use	4.9670	10.92	0.22
Salicylic acid	"	3.5186	0.85	0.024
Oxalic acid	"	0.1211	35.19	29.1
Stearic acid	Oil-type	2.4937	0.42	0.017

Note: Dehydrated Solvent KTX should be used in combination with Karl Fischer Reagent SS-Z, and Dehydrated Solvent CP with Karl Fischer Reagent SS.

(2) Coulometric titration

Reagents used: Aquamicon AKX (or AX) 100ml
Aquamicon CXU 5ml

Substance	Electrolyte	Sample quantity(g)	Measurement value (μ g)	Moisture content (ppm)
Formic acid	Ketone-type	1.220	Not measurable	
Acetic acid	"	1.050	687	655
Propionic acid	"	0.993	1321	1330
Dichloroacetic acid	"	1.563	1313	840
Salicylic acid	General-use	1.6222	341	210
Stearic acid	"	2.1418	130	61
Oxalic acid	"	0.0222	6645	29.9%

9. Esters**Key Points**

Esters are substances for which moisture content can be measured very easily using standard Karl Fischer titration procedures. There are no significant interference reactions and behavior is similar to that of hydrocarbons. Both volumetric and coulometric titration can be used without any problem.

For volumetric titration, a general-use dehydrated solvent is used.

Solubility will be a problem with long-chain aliphatic esters and a dehydrated solvent formulated for oils is recommended.

With coulometric titration, measurements are carried out by adding the sample directly to the electrolyte (anolyte).

Examples of substances that can be measured directly:**Esters**

Methyl formate, ethyl formate, methyl acetate, ethyl acetate, aryl formate, methyl acrylate, methyl methacrylate, ethyl malonate, methyl valerate, methyl adipate, methyl sebacate, methyl glycolate, 2,3-butylene di-acetate, ethyl citrate, cyclohexyl acetate, methyl benzoate, methyl salicylate, phenyl acetate

Inorganic esters

Ethyl carbonate, ethyl chlorocarbonate, butyl nitrite

Lactones

γ-butyrolactone

Carbamic acid esters

Methyl carbamate, ethyl carbamate

[Examples of Measurement]**(1) Volumetric titration**

Reagents used: Karl Fischer Reagent SS-Z (or SS) 25-50ml
Dehydrated Solvent GEX (or MS)

Substance	Dehydrated solvent	Sample quantity (g)	Measurement value (μg)	Moisture content (ppm)
Methyl acetate	General-use	0.9647	2.15	2224
Ethyl acetate	"	4.3557	0.86	197
Methyl acrylate	"	2.8098	5.31	1890
γ-Butyrolactam	"	5.6364	1.18	210

(2) Coulometric titration

Reagents used: Aquamicon AX (or AS) 100ml
Aquamicon CXU 5ml

Substance	Sample quantity (g)	Measurement value (μg)	Moisture content (ppm)
Methyl acetate	2.5250	105	42
Methyl isoamyl	0.8548	1280	1494
n-Butyl acetate	2.4589	195	79
Isopropyl isovalerate	0.9186	1256	1367
Di-isopropyl malonate	1.0740	449	418
Benzyl benzoate	1.5825	319	202
γ-Butyrolactam	3.1695	512	162

10. Organic Acid Salts**Key Points**

Since organic acid salts containing water of crystallization dissolve readily in methanol, their moisture content can be measured easily using a general-use dehydrated solvent. In the case of organic acid salts that do not contain water of crystallization, moisture content can be measured by dissolving or dispersing the substances in a general-use dehydrated solvent. As these substances are solids with a high moisture content, we recommend measurement using volumetric titration.

The organic salt sodium tartrate dihydrate was formerly used as a standard reagent for determining the titer of Karl Fischer reagents for use in volumetric titration.

Examples of substances that can be measured directly:**Organic acid salts containing water of crystallization**

Barium acetate, cadmium acetate, cobalt acetate, lead acetate, magnesium acetate, nickel acetate, sodium acetate, zinc acetate, uranyl acetate, sodium citrate, lithium citrate, calcium lactate, calcium malonate, sodium naphthionate, ammonium oxalate, potassium oxalate, calcium propionate, sodium succinate, sodium benzoate, sodium tartrate

Organic acid salts without water of crystallization

Ammonium acetate, sodium adipate, potassium hydrogen tartrate, ammonium citrate, sodium formate, sodium phthalate, zinc stearate

[Examples of Measurement]**(1) Volumetric titration**

Reagents used: Karl Fischer Reagent SS-Z (or SS) 25-50ml
Dehydrated Solvent GEX (or MS)

Substance	Dehydrated solvent	Sample quantity (g)	Measurement value (mg)	Moisture content (%)
Sodium L-aspartate	General-use	0.0841	4.32	5.14
Lithium citrate	"	0.0354	8.73	24.7
Sodium citrate	"	0.0812	10.08	12.4
Ammonium acetate	"	1.2884	6.44	0.500
Cadmium acetate	"	0.2750	37.07	13.5
Magnesium acetate	"	0.1918	64.27	33.5
Lithium acetate	"	0.1003	4.13	11.5
Sodium acetate	"	0.0678	10.75	15.8
Sodium naphthionate	"	0.0731	5.85	22.8
Calcium lactate	"	0.2003	58.39	29.2
Oxalic acid	"	0.0825	23.58	28.6
Manganese benzoate	"	0.0862	9.45	11.0
Calcium stearate	Oil-type	0.2046	5.9	2.92

[Examples of Measurement]**(1) Volumetric titration**

Reagents used: Karl Fischer Reagent SS-Z (or SS)

Dehydrated Solvent GEX (or MS) 25-50ml

Substance	Dehydrated solvent	Sample quantity (g)	Measurement value (mg)	Moisture content (%)
Chloral hydrate	General-use	0.1752	19.27	11.0
Hydrazine hydrate	"	0.0732	25.68	35.1

11. Organic Hydrates**Key Points**

Since organic hydrates are solids, measurements can normally be carried out directly using volumetric titration. For measurements using volumetric titration, these substances can be dissolved or dispersed in a general-use dehydrated solvent. As with organic acid salts, volumetric titration is generally recommended for organic hydrates.

Water of crystallization is not always stable in organic hydrates and moisture content frequently varies with reference to temperature and humidity. Cyanuric acid, in particular, tends to lose most of its water of crystallization.

Examples of substances that can be measured directly:

Pyromellitic acid, L-asparagine, creatine, L-histidine, dextrose, L-rhamnose, raffinose, chloral hydrate, ninhydrin, alloxan, piperazine, o-phenantholine, brucine, brucine sulfate

12. Amines

Key Points

Some amines exhibit unusual behavior during Karl Fischer titration. That behavior falls into two categories; that caused by basicity and that caused by other chemical interference reactions. The titration conditions must be modified in accordance with the nature of the behavior that is involved.

In terms of basicity, substances can be divided into two groups using benzylamine with a pKa value of 9.4 ($K_a=2.4 \times 10^{-5}$) as the dividing line.

1) Amines below pKa9.4

Titration can be carried out without difficulty using standard procedures and behavior is comparable with hydrocarbons. In the case of volumetric titration, the substances are dissolved in a general-use dehydrated solvent and titrated directly. With coulometric titration, the sample is introduced into a general-use electrolyte (anolyte) and titrated directly.

2) Amines with strong-basicity (above pKa9.4)

Aside from the Karl Fischer reactions with water, interference reactions caused by the strong basicity of these substances gradually consume the Karl Fischer reagent and are known to cause the following phenomena.

- Poor end point stability
- Failure to reach end point
- Abnormally high analytical results

To suppress these interference reactions, the substances must be neutralized with acids before titration and the Karl Fischer titration system must be kept in a state that is close to neutrality. Salicylic acid is normally used for this purpose as it causes almost no esterification reaction with titration solvents which have methanol as their main ingredient. If acetic acid is used, the esterification reaction must be suppressed by chilling the system to 15 °C or below during the Karl Fischer titration.

For volumetric titration the titration solvent is prepared by dissolving 10g of salicylic acid in 50ml of Dehydrated Solvent GEX (or MS).

For coulometric titration the electrolyte is prepared by dissolving 10g of salicylic acid in 100ml of general-use electrolyte (anolyte).

Note: Up to 70mmol of amine can be neutralized with 10g of salicylic acid. This is why titration is normally carried out continuously with a quantity that corresponds to a sample of 70mmol.

Substances that react with electrodes or cause other interference reactions

Coulometric titration cannot be used for substances that react with electrodes, such as aniline, toluidine, diamines and aminophenol.

With substances such as aniline or toluidine, the end point will not be clear if methanol is used as the titration solvent for volumetric titration. Volumetric titration is possible, provided that Dehydrated Solvent CP is used. Diamines cause an interference reaction with iodine, with the result that the end point is never reached.

- Reference:**(1) Muroi, K. et al., "Measuring Trace Moisture Content in Amines Using the Karl Fischer Method" (in Bunseki Kiki [Analytical Equipment] 8, 374, 1969).
(2) Kato, H. et al., "Determination of Moisture in Amines by Karl Fischer Coulometric Titration" (in Bunseki Kagaku 34, 805 (1985)).

Examples of substances that can be measured directly using standard methods:

Pyridine, 2-aminopyridine, 2-picoline, quinoline, pyrrole, imidazole, triazine, triazole, indole, carbazole, benzothiazole, N,N-dimethylaniline, diphenylamine, 2-pyridyl ethanol, 4-pyridyl ethanol

Examples of substances that require neutralization with acid:

Trimethylamine, ethylamine, diethylamine, triethylamine, propylamine, isopropylamine, 3-methoxypropylamine, butylamine, di-isobutylamine, disec- butylamine, dipentylamine, hexylamine, N,N-dimethylcyclohexylamine, dicyclohexylamine, benzylamine, pyrrolidine, piperidine, piperazine, morpholine, ethanolamine, N,N-dimethylethanolamine, diethanolamine, triethanolamine, di-isopropanolamine, tri-isopropanolamine, Tris (hydroxymethyl) aminomethane

Examples of substances that require a methanol-free titration solvent:

Aniline, toluidine, anisidine, naphthylamine

[Examples of Measurement]**(1) Volumetric titration --neutralization using salicylic**

Reagents used: Karl Fischer Reagent SS-Z (or SS) approx. 50ml
 Dehydrated Solvent GEX (or MS) approx. 10g
 Salicylic acid approx. 10g

Substance	Dehydrated solvents	Sample quantity(g)	Measurement value (mg)	Moisture content (%)
n-Butylamine	General-use+Salicylic acid	0.7335	1.45	0.20
Diethylamine	"	0.7234	1.02	0.14
Diethanolamine	"	1.0240	2.62	0.26
Piperidine	"	0.9034	1.00	0.11
Tri-n-butylamine	"	1.6367	1.27	0.077
Di-isopropyl amine	"	1.5010	1.21	0.081
2-Methylaminopyridine	"	1.052	0.47	0.12
Triethanolamine	"	1.124	0.70	0.17
N-Ethyl morpholine	"	0.905	0.88	0.26
N,N-Dimethyl benzylamine	"	0.900	1.55	0.17
N-Ethyl aniline	"	0.958	0.55	0.057
Aniline	Ketone-type	1.0185	1.49	0.15

Note: Salicylic acid crystals are bulky and difficult to handle. To overcome this problem, place 10g of salicylic acid in an empty titration flask and add Dehydrated Solvent GEX. The salicylic acid will dissolve readily and can be rendered moisture-free through a Karl Fischer titration that prepares for the main titration.

(2) Coulometric titration

Reagents used: Aquamicon AX (or AS) 100ml
 or with approx. 10g of Salicylic acid added
 Aquamicon CXU 5ml

Substance	pKa	Sample quantity(g)	Measurement value (µg)	Moisture content (%)
i-Propylamine	10.6	0.694	321	463ppm
n-Butylamine	10.6	0.732	2440	0.333
n-Hexylamine	10.6	0.766	496	648ppm
Diethylamine	11.0	0.707	989	0.140
Di-i-propylamine	11.1	0.722	931	0.129
Di-n-butylamine	11.3	0.760	3231	0.425
Triethylamine	10.7	0.726	5582	0.769
Tri-n-propylamine	10.7	0.753	1159	0.154
Tri-n-butylamine	10.9	0.778	626	805ppm
3-Dimethylamino propionitrile	6.9	0.870	2635	0.303
Cyclohexylamine	10.6	0.867	1741	0.201
Monoethanolamine	9.5	0.269	614	0.228
Diethanolamine	9.0	1.097	1199	0.109
Triethanolamine	7.8	1.124	1870	0.166
2-Diethylaminoethanol	9.4	0.884	2757	0.321
1,3-Diaminopropane		0.218	1471	0.675
1,2-Propane diamine			Cannot be measured	
Pyrrolidine	11.3		Cannot be measured	
Piperidine	11.2	0.861	3971	0.461
4-Benzyl piperidine	10.3	0.997	6314	0.633
Piperazine		0.200	210	0.105
Pyrrole		0.967	3104	0.321
N-Methyl morpholine	7.7	0.905	1907	0.211
Benzylamine	9.4	0.268	452	0.169
N,N-Dimethyl benzylamine	8.9	0.900	1042	0.116
2-Amino-3-picoline	6.7	1.031	2621	0.254
2-Methyl aminopyridine	6.7	1.052	1280	0.122
o-Toluidine	4.4		Cannot be measured	
m-Toluidine	4.7		Cannot be measured	
p-Anisidine	5.3		Cannot be measured	
m-Aminophenol	4.2		Cannot be measured	
Dimethyl aminomethyl phenol	7.9	0.986	1606	0.163
N,N-Dimethyl-p-toluidine	5.6	0.937	494	527ppm
Aniline	4.6		Cannot be measured	
N,N-Diethyl aniline	6.6	0.938	102	109ppm
o-Chloro-aniline	2.6	1.213	361	298ppm
2-Anilinoethanol	4.0	1.085	2614	0.241

13. Amides, Anilides

Key Points

The moisture content of amides and anilides can be measured easily using standard methods. Amides behave in the same way as weakbasicity amines. Both volumetric and coulometric titration can be used.

For volumetric titration, use either a general-use or an oil-type dehydrated solvent, depending on the solubility of the sample.

In the case of coulometric titration, the sample is added directly to the electrolyte (anolyte).

Examples of substances that can be measured directly:

Formamide, acetamide, malonamide, dimethyl formamide, urea, ethylene urea, biuret, acetyl urea, alloxan, benzamide, salicylamide, acetanilide, propionanilide

[Examples of Measurement]

(1) Volumetric titration

Reagents used: Karl Fischer Reagent SS-Z (or SS)
Dehydrated Solvent GEX (or MS) 25-50ml

Substance	Dehydrated solvents	Sample Quantity (g)	Measurement Value (mg)	Moisture Content (%)
Formamide	General-use	2.2307	1.71	0.077
N,N-Dimethyl formamide	"	2.6466	3.28	0.124
Urea	"	2.5000	1.40	0.056
Acetanilide	"	4.9110	10.35	0.21
Stearamide	Oil-type	3.6953	0.15	0.004

(2) Coulometric titration

Reagents used: Aquamicon AX (or AS) 100ml
Aquamicon CXU 5ml

Substance	Sample Quantity (g)	Measurement value (µg)	Moisture Content (ppm)
Formamide	2.1173	1510	713
N,N-Dimethyl formamide	2.6484	552	208
Acetamide	4.6866	314	67
N,N-Dimethyl acetamide	1.1590	707	612
Oleylamide	2.1790	78	36
Erucamide	3.8854	148	38

14. Nitriles, Cyanohydrins

Key Points

Nitriles have weak basicity and can be measured easily using standard methods. Reliable moisture measurement is also possible with cyanohydrins. Both volumetric and coulometric titration can be used.

For volumetric titration, a general-use dehydrated solvent is used. For coulometric titration, the sample is added directly to the electrolyte (anolyte).

Examples of substances that can be measured directly:

Acetonitrile, aminoacetonitrile, acrylonitrile, sebaconitrile, methylene aminoacetonitrile, adiponitrile, acetone cyanhydrin, formaldehyde cyanohydrin, acrolein cyanohydrin acetate

[Examples of Measurement]

(1) Volumetric titration

Reagents used: Karl Fischer Reagent SS-Z (or SS)
Dehydrated Solvent GEX (or MS) 25-50ml

Substance	Dehydrated solvents	Sample Quantity (g)	Measurement Value (mg)	Moisture Content (%)
Acetonitrile	General-use	2.1687	3.22	0.148

(2) Coulometric titration

Reagents used: Aquamicon AX (or AS) 100ml
 Aquamicon CXU 5ml

Substance	Sample quantity (g)	Measurement value (µg)	Moisture Content (ppm)
Acetonitrile	0.7691	822	1070
Acrylonitrile	0.080	295	3690

15. Hydrazines**Key Points**

Iodine oxidation causes hydrazine derivatives to react with Karl Fischer reagent as shown in the following formula.

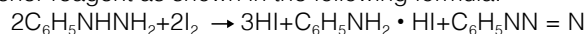

Karl Fischer titration is possible also with acidic solvents. Moisture content can be measured without this reaction if the sample is first dissolved in an excess of acetic acid (approx. 2g of sample in 25ml of acetic acid).

The moisture content of dinitrophenyl hydrazine and benzoyl hydrazine can also be measured accurately if the sample is dissolved in acetic acid and then titrated. Hydrazine hydrochloride reacts with iodine on a mole-for-mole basis, but hydrazine sulfate does not react with Karl Fischer reagent and can be dissolved in methanol for titration.

In the case of hydrazine compounds, volumetric titration is the only method that can be used. Coulometric titration is not suitable.

[Examples of Measurement]**(1) Volumetric titration**

Reagents used: Karl Fischer Reagent SS-Z (or SS) 50ml
 Dehydrated Solvent GEX (or MS) approx.
 Titrate after cooling to 15°C or lower.

Substance	Dehydrated solvents	Sample quantity (g)	Measurement Value (mg)	Moisture Content (%)
Hydrazine	General-use	0.0296	0.84	2.85

Substance	Sample moisture (%)	content (%)Amount added	
		Added moisture	Measurement value
Semicarbazide hydrochloride	0.39±0.00	2.52	2.50
Phenylhydrazine hydrochloride	0.37±0.01	2.50	2.53

16. Other Nitrogenous Compounds**Key Points**

Both volumetric and coulometric titration can be used directly for other nitrogenous compounds. For volumetric titration, the substance is dissolved in a general-use dehydrated solvent and titrated. If a substance is difficult to dissolve its solubility can be improved with the addition of another solvent.

Coulometric titration is carried out using a general-purpose electrolyte and in accordance with standard procedures.

Examples of substances that can be titrated directly:**Lactam, Imines**

ε-Caprolactam, benzal-n-butylimine

Cyanohydrine

Formaldehyde cyanohydrin, acetone cyanhydrin, acrolein cyanohydrines

Azo-, azole compounds

p-Aminoazobenzene, diazoaminobenzene, benzotriazole

Isocyanates, nitroso compounds

1-Naphthyl isocyanate, phenyl isocyanate, N-nitrosodiphenylamine

Nitro compounds

Nitromethane, nitroglycerine, 2-nitropropane, m-dinitrobenzene, 3,5-dinitrobenzoic acid

Oximes, hydroxamic acids

Acetone oxime, dimethylglyoxime, butylaloxime, hepta-aldoxime, cyclohexanone oxime

Cyanic acid derivatives

Cyanamides, dicyanamides, cyanuric acid, melamine

Amidines

Guanidine nitrate

[Examples of Measurement]**(1) Volumetric titration**

Reagents used: Karl Fischer Reagent SS-Z (or SS) 25-50ml
Dehydrated Solvent GEX (or MS)

Substance	Dehydrated solvents	Sample Quantity (g)	Measurement Value (mg)	Moisture Content (%)
Nitromethane	General-use	5.6235	0.99	0.018
Nitroethane	"	2.0672	4.63	0.22
1-Nitropropane	"	1.8575	2.75	0.15
m-Nitroaniline	"	2.3233	1.26	0.054
p-Nitrophenol	"	0.9844	11.30	1.15
o-Nitro-p-chloroaniline	"	0.9209	0.30	0.033
m-Dinitrobenzene	"	1.0835	0.15	0.014
2,4-Dinitrotoluene	"	1.9935	0.06	0.003
ε-Caprolactam	"	1.5336	3.22	0.21
N-Methyl pyrrolidine	"	3.1519	2.14	0.068
m-Nitro-p-toluidine	*1	2.1785	0.45	0.021
p-Dichloro nitrobenzene	*2	10.1400	0.78	0.008

*1: Dehydrated Solvent MS 25ml + dinitromethane 10ml

*2: Dehydrated Solvent MS 25ml + dichloromethane 10ml

(2) Coulometric titration

Reagents used: Aquamicon AX (or AS) 100ml
Aquamicon CXU 5ml

Substance	Sample Quantity (g)	Measurement value (μg)	Moisture Content (ppm)
Nitromethane	1.1312	993	879
Nitroethane	1.0237	2224	0.217%
1-Nitropropane	0.9757	1324	0.136%
2-Nitropropane	1.0338	816	789
p-Nitrophenol	0.5195	5507	1.060%
m-Nitroaniline	1.5120	875	579
m-Nitro-p-toluidine	2.0193	404	200
o-Nitro-p-chloroaniline	1.0060	295	293
N-Vinyl pyrrolidone	1.0675	340	319
ε-Caprolactam	0.6448	1290	0.200%
Isocyanate	3.3597	95	28

In all cases, samples can be measured up to a volume of 20-50ml, as shown in the table.

17. Acid Anhydrides**Key Points**

Acid anhydrides and acylates can be measured directly using volumetric titration. The sample is subjected to Karl Fischer titration after it has been dissolved in either a general-use dehydrated solvent or a compound solvent made up of one part pyridine to four parts methanol by volume.

Examples of substances that can be titrated directly:**Acid Anhydrides**

Acetic anhydride, propionic anhydride, butyric anhydride, n-valeric anhydride, succinic anhydride, benzoic anhydride, phthalic anhydride

18. Acid Chlorides**Key Points**

The following acid chlorides cause interference through oxidation of the hydriodic acid in Karl Fischer reagent and the release of free iodine. For this reason, water content is measured using volumetric titration as follows.

To suppress the interference, neutralize the sample by adding 1-3g of the sample to a methanol solvent that includes 20% pyridine/sulfur dioxide (SO₂ 32g/pyridine 100ml). Then carry out the Karl Fischer titration.

1) Potassium dichloroisocyanurate

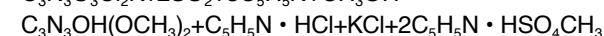
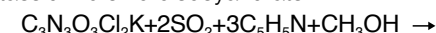

2) Aryl sulfonyl chloride

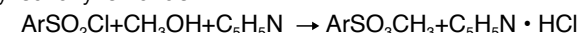

Coulometric titration cannot be used because of the interference.

Examples of substances that can be titrated directly:**Acid Chlorides**

Propionyl chloride, butyryl chloride, valeryl chloride, caproyl chloride, capryl chloride, stearoyl chloride, benzoyl chloride

[Examples of Measurement]**(1) Volumetric titration**

Reagents used: Karl Fischer Reagent SS
Dehydrated Solvent MS + SO₂/pyridine solvent 25-50ml

Substance	Sample quantity (g)	Measurement value (mg)	Moisture Content (%)
Potassium dichloroisocyanurate	1.0228	2.45	0.24*
p-Toluene sulfonyl chloride	1.0541	0.82	0.078
p-Chlorobenzene sulfonyl chloride	1.0059	1.20	0.12**
Toluene 2,4-disulfonyl chloride	0.8721	2.18	0.25
p-Ethylbenzene sulfonyl chloride	1.6708	0.54	0.032
Methanesulfonyl chloride	2.9444	2.10	0.071

*: Drying method 0.23%

** : Infrared method 0.14%

19. Quinones**Key Points**

Quinones interfere with the titration through the oxidation of hydriodic acid, which is produced from a reaction between water and Karl Fischer reagent, to produce free iodine. For this reason, direct titration is impossible. Instead, an indirect method based on water vaporization is used.

Either volumetric or coulometric Karl Fischer titration can be used. Refer to the section on Basic Knowledge for information on the water vaporization method.

[Examples of Measurement]**(1) Water vaporization - Volumetric titration**

Reagents used: Karl Fischer Reagent SS-Z (or SS)
Dehydrated Solvent GEX (or MS) + PG (3:1) 50-100ml

Substance	Heating temperature (°C)	Sample quantity (g)	Measurement value (mg)	Moisture content (%)
Naphthoquinone (wet)	160	0.1185	7.62	6.43
Naphthoquinone (dry)	160	2.2096	0.82	0.037
p-Quinone	130	3.5710	0.15	0.0042

20. Peroxides**Key Points**

As shown in the following formula, peroxides react with the sulfur dioxide in Karl Fischer reagent. In general, however, there is no interference.

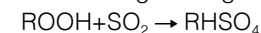

It is important to ensure that there is always an adequate excess of sulfur dioxide.

Acetyl peroxide is highly reactive and causes interference by releasing iodine through the oxidation of hydrogen iodide.

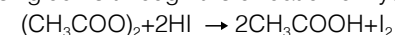

Other substances may also cause interference if there is insufficient sulfur dioxide. Dialkyl peroxides (R-OO-R) are not reactive and have no effect on Karl Fischer titration. Diacyl peroxides (RCO-OO-OCR) cause interference through the oxidation of hydrogen iodide as shown in the following formula.

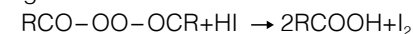
**Examples of substances that can be measured directly:**

Di-tert-butyl peroxide (this substance causes an exothermic reaction when titrated with Karl Fischer reagent, but moisture content can be measured accurately), diethyl peroxide, lauryl peroxide, triacetone peroxide

21. Sulfur Compounds

Key Points

The moisture content of most sulfur compounds, including sulfides, disulfides, thiocyanic acid and sulfonic acid, can be measured by means of direct titration using standard procedures. As with hydrocarbons, these compounds have a tendency to slow the rate of the reaction between water and Karl Fischer reagent, so they should always be measured in excess methanol.

For volumetric titration, the substances are measured after they have been dissolved in a general-use dehydrated solvent.

For coulometric titration, the sample is added directly to a general-use electrolyte (anolyte).

The only substances that cause interference are mercaptan, thiourea, thioacetic acid and dithio acid. These consume Karl Fischer reagent by reacting with iodine as shown in the following formulae.

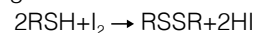

Before these substances can be titrated, they must be neutralized using special procedures.

Dimethyl sulfoxide (DMSO) exhibits unusual behavior. Karl Fischer titration appears to move toward a stable end point without any difficulty, but with sequential addition of the sample the moisture content declines with each analysis. It is important to note that the presence of DMSO reduces the percentage of water recovered.

Examples of substances that can be measured directly:

Sulfides

Carbon disulfide, allyl sulfide, n-butyl sulfide, n-butyl disulfide, thiophene, benzothiophene

Thiocyanates, etc.

Ethyl thiocyanate, ethylene thiocyanate, n-butyl thiocyanate, ethyl isothiocyanate, 1-naphthyl isothiocyanate, ethyl thioacetate, benzothiazole, 1-acetyl-2-thiourea, methyl isothiurea

[Examples of Measurement]

(1) Volumetric titration

Reagents used: Karl Fischer Reagent SS-Z (or SS)

Dehydrated Solvent GEX (or MS) 25-50ml

Substance	Dehydrated solvent	Sample quantity (g)	Measurement value (mg)	Moisture content (ppm)
Carbon disulfide	General-use	6.3050	0.62	98
Dimethyl sulfoxide	"	3.0721	0.92	298

(2) Coulometric titration

Reagents used: Aquamicon AX (or AS)

Aquamicon CXU 100ml
5ml

Substance	Sample quantity (g)	Measurement value (μg)	Moisture Content (ppm)
Dimethyl sulfoxide	1.0773	784	728
Benzothiophene	1.1633	158	136

Measuring the Moisture Content of Mercaptan

Interference caused by mercaptan can be eliminated by reacting an active olefin such as octene with the sample using boron trifluoride as the catalyst.

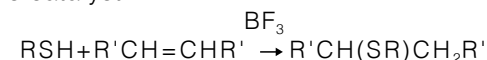

- a) Reagent Solution of boron trifluoride and ethyl ether (BF₃ 45%)
or Solution of boron trifluoride and acetic acid (100g BF₃/l)
Isooctene, glacial acetic acid, pyridine

- b) Measurement method

Put 5-10ml of glacial acetic acid into a 250ml measuring flask. Add the sample making sure that the amount of mercaptan does not exceed 15 millimoles. Next, add 3ml of boron trifluoride/ethyl ether solution or 10ml of boron trifluoride/acetic acid solution and 6ml of isooctene. Mix well and leave for about 30 minutes at room temperature. Carefully add 5ml of pyridine and then titrate the solution with Karl Fischer reagent. Using the same procedures, obtain a dummy test result for the reagent. Subtract this from the titration value to determine the moisture content. However, the reagent used should always be thoroughly dehydrated. (JACS., 62, 1 (1940))

Note: An error will occur at the rate of 0.3ppm of water for every 1ppm of sulfur in the mercaptan. If the mercaptan content is low, an accurate measurement of the moisture content can be obtained by adjusting the measurement value.

Reference: JISK2275 Crude oil and petroleum products - Determination of water content

Test Examples

Sample	Moisture (%)	Content (%)	
		Added moisture	Observed moisture(%)
Ethyl mercaptan	0.70	6.30	6.35
Isopropyl mercaptan	0.90	6.30	6.25
Butyl mercaptan	0.85	3.05	3.05
Isoamyl mercaptan	0.40	2.85	2.90
Hexyl mercaptan	0.15	1.85	1.85
Heptyl mercaptan	0.70	4.60	4.60
Benzyl mercaptan	0.25	2.80	2.80
Thiophenol	0.25	-	-
2-Thionaphthol	0.05	1.35	1.35
Thioglycollic acid	3.85	6.95	7.00

Other Substances that Cause Interference

It may not be possible to obtain a clear end point with thiourea as it reacts with iodine. This is because thiourea triggers tautomerism and interconverts to isothiurea, which causes the same reaction as mercaptan.

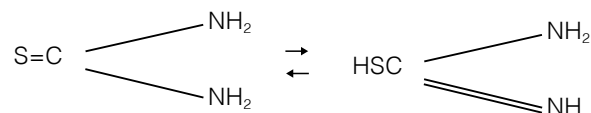

1-Phenyl-2-thiourea, 1, 3-diphenyl thiourea and thiobenzamide also react in the same way as thiourea. However, N-methyl thiourea and 1-acetyl-2-thiourea can be titrated directly without causing a reaction.

When thioacetic acid is titrated directly, it reacts quantitatively with Karl Fischer reagent and consumes 1 mole of iodine per mole. Dithio acid causes a similar quantitative reaction. This interference can be prevented by taking the following preliminary steps.

First, add an equivalent amount of n-butanol to the sample and treat it with olefin using boron trifluoride as the catalyst. It appears that the butyl mercaptan produced in this way combines with the olefin as shown in the following formulae.

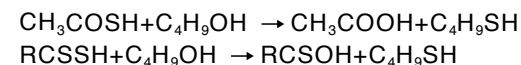

If excess butanol is used it will react with the acid during titration and produce ester and water. The results must be corrected to allow for this.

II-2. Inorganic Compounds

Interference reactions are more common with inorganic compounds than with organic compounds. Refer to the comments on interference in Q9 of the section on Basic Knowledge. Also, the moisture vaporization method is used more often because there are a number of substances that cannot be dissolved in the titration solvents. For each substance, it is essential to consider whether or not to use the moisture vaporization method (heat vaporization system). In addition, when taking measurements careful consideration must be given to the way in which moisture is present (adhesion water or compounded water).

1. Metals and Simple Substances

Key Points

Since these substances are solids and cannot be dissolved in methanol, they are normally measured using the moisture vaporization method. The sample is powdered in preparation for the measurement.

During this preliminary process it is important to prevent absorption of humidity or dissipation of the moisture content.

For volumetric titration, it is possible to disperse the sample in dehydrated solvent and carry out Karl Fischer titration directly.

However, the moisture vaporization method is normally used.

With coulometric titration the presence of insoluble substances, such as powdered metal, interferes with the electrode reaction. Other causes of interference include membrane blockage. For these reasons, coulometric titration cannot be used directly.

In most cases the moisture vaporization method is effective with these samples. Because moisture content is commonly low, Karl Fischer titration is carried out using the coulometric method. The heating temperature for moisture vaporization is 100-250°C. If necessary, the process can be carried out at temperatures of 600-700°C.

[Examples of Measurement]**(1) Volumetric titration**

Reagents used: Karl Fischer Reagent SS-Z (or SS) 25-50ml
Dehydrated Solvent GEX (or MS)

Substance	Dehydrated solvent	Sample quantity (g)	Measurement value (mg)	Moisture content (%)
Aluminum paste	General-use	0.2524	0.83	0.329
Powdered aluminum + oil	"	0.5968	0.15	0.075
Powdered tungsten	"	4.2880	0.71	0.017
Titanium	"	0.4541	10.97	2.42
Sulfur	"	1.1710	0.47	0.042
Ferrite	"	0.3121	11.11	3.56

(2) Coulometric titration

Reagents used: Aquamicon AX (or AS) 150ml
Aquamicon CXU 10ml

Substance	Heating Temperature (°C)	Sample quantity (g)	Measurement value (µg)	Moisture content (%)
Aluminum paste	110	0.2646	3831	1.45
Powdered aluminum	600	3.3284	524	157ppm
Powdered metal (Cd)	110	0.2572	354	0.138
"	250	0.1494	787	0.527
Powdered metal (zinc)	250	3.8345	35	9ppm
Powdered silicon	700	0.0537	1252	2.33
Powdered cobalt alloy	200	2.3461	563	240ppm
Powdered brass	250	1.5277	1951	0.128
Copper wire	200	2.4454	332	136ppm
Powdered lead tin	400	9.9006	531	54ppm
Nickel	250	1.0724	316	295ppm
Powdered sulfur	100	2.3143	151	65ppm
Red phosphorus	180	0.2036	1470	0.722
Ferrite	700	0.0774	3034	3.92

2. Inorganic Acids**Key Points**

The following problems arise when methanol is used as the titration solvent for inorganic acids.

- 1) The pH of the Karl Fischer titration system is shifted to the acid side. This lowers the reaction rate.
- 2) An esterification reaction occurs with acids at high temperatures. This produces water, raising the measurement value.

To suppress these interference reactions the sample should be neutralized with an amine, such as pyridine, before Karl Fischer titration.

Since these substances commonly have a high moisture content, volumetric titration is used. It is convenient to use Dehydrated Solvent MS (manufactured by Mitsubishi Chemical). As this product contains a relatively high percentage of pyridine as a reaction accelerant, it is not necessary to add more pyridine.

In the case of hydrogen chloride gas, moisture is condensed in special apparatus at -78°C. The main constituent, hydrogen chloride, is then separated so that the condensed water can be dissolved in pyridinemethanol and titrated.

Reference: Muroi, Ono: Microchem.J., 18,234 (1973)
"Determination of Trace Moisture in Hydrogen Chloride Gas by Karl Fischer Titration"

Examples of test methods**1) Sulfuric acid**

Concentrated sulfuric acid (95% or higher) causes an esterification reaction in methanol and produces water. By adding 50ml of Dehydrated Solvent MS and using a small sample (approx. 0.5g or less), it is possible to carry out direct titration without any interference reaction.

2) Nitric acid

The reagent nitric acid can be titrated directly by adding about 0.3g of sample to 50ml of Dehydrated Solvent MS. In the case of fuming nitric acid, the sample will have to be neutralized with pyridine.

3) Hydrochloric acid

The reagent hydrochloric acid can be titrated directly by adding about 0.03g of sample to 50ml of Dehydrated Solvent MS.

4) Hydrofluoric acid

The reagent hydrofluoric acid can be titrated directly by adding about 0.03g of sample to 50ml of Dehydrated Solvent MS. However, as hydrofluoric acid erodes glass parts of the titration cell and the electrodes, teflon-coated parts should be used.

5) Hydrocyanic acid

The reagent hydrocyanic acid can be dissolved in Dehydrated Solvent MS for direct titration.

[Examples of Measurement]**(1) Volumetric titration**

Reagents used: Karl Fischer Reagent SS-Z (or SS)
Dehydrated Solvent GEX (or MS) 25-50ml

Substance	Dehydrated solvent	Sample quantity (g)	Measurement value (mg)	Moisture content (%)
97% Sulfuric acid	General-use	0.2423	7.69	3.17
92% Sulfuric acid	"	0.1145	8.74	7.63
Nitric acid	"	0.0360	35.04	97.3
Nitric acid (85%)	"	0.1155	16.87	14.6
Hydrochloric acid (38%)	"	0.0379	23.67	62.5
Hydrofluoric acid (48%)	"	0.0368	18.96	51.5
Hydrocyanic acid	"	0.3888	5.56	1.43
Phosphoric acid (85%)	"	0.0533	7.85	14.7

Hydrogen chloride gas

Hydrogen chloride gas reacts with Karl Fischer reagent and cannot be titrated directly. The moisture content is titrated after condensation in a trap at -78°C , using the following procedures.

a) To ensure that the system is free of moisture, nitrogen gas that has first been dried with silica gel and phosphorus pentoxide is passed inside titration flask D in the direction $L \rightarrow M \rightarrow y$ at a rate of approximately 0.5l/min. (The moisture content of the nitrogen that passed through the system is titrated.)

- b) Titration flask D is cooled to -78°C in a methanol dry ice cooling bath.
 c) Immediately after the nitrogen flow has been stopped, the sample gas is passed into titration flask D in the direction $A \rightarrow M \rightarrow y$ at a rate of approximately 0.5l/min.
 d) When 5-20l of gas has passed through the system, the three-way cock is switched to allow nitrogen to flow into titration flask D in the direction $L \rightarrow M \rightarrow y$ for about one minute to drive out all of the sample gas.
 e) The flow of nitrogen is then stopped and 20ml of a 1:1 pyridine/methanol solution is introduced from B to flush out the water that has condensed in E.
 f) Titration flask D is removed from the methanol dry ice cooling bath. When the flask has returned to room temperature, the water captured in the pyridine/methanol solution is titrated.
 g) A dummy value is established from 20ml of pyridine/methanol solution using the same procedures. Moisture content is determined by subtracting this value from the titration result.

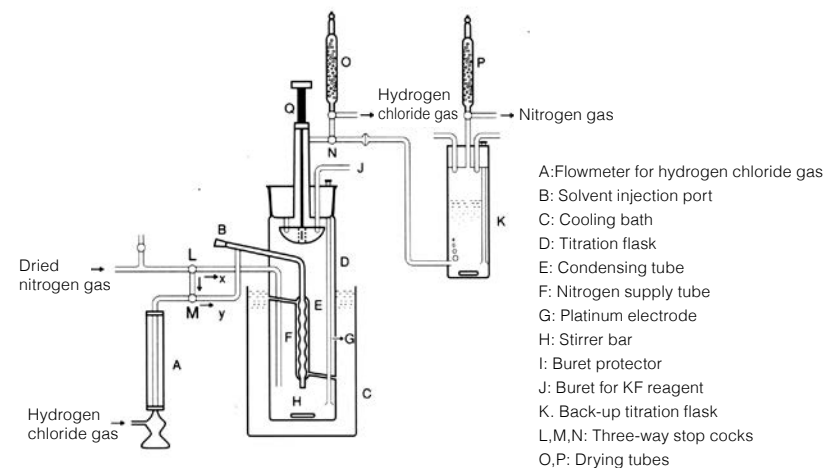

Figure 20: Titration Apparatus for Hydrogen Chloride Gas

Test Examples

Gas flow rate (l/min.)	Volume (l)	Measurement value (mg)	Moisture content (ppm)
0.3	20	0.44	12.6
0.4	20	0.43	12.4
0.5	20	0.45	12.8
0.6	20	0.40	11.5
0.7	20	0.38	10.4
0.8	20	0.33	9.4

Note:Karl Fischer Reagent SS with a titer of 0.35mg/ml was used.
(At present there is no reagent with this titer.)

3. Hydroxides**Key Points**

Metallic hydroxides generally react with the iodine in Karl Fischer reagent in accordance with the following formula. In particular, alkaline metal and alkaline earth hydroxides (strong basicity) react quantitatively and rapidly.

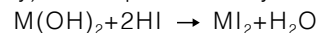

For example, lithium hydroxide, sodium hydroxide, potassium hydroxide and barium hydroxide all produce water and react immediately with Karl Fischer reagent. For this reason, direct titration cannot be used.

Moisture content is measured using the moisture vaporization method.

[Examples of Measurement]**(1) Moisture vaporization - Coulometric titration**

Reagents used: Aquamicon AX (or AS)	150ml
Aquamicon CXU	10ml

Substance	Heating temperature(°C)	Sample quantity (g)	Measurement value (µg)	Moisture content (%)
Calcium hydroxide	110	0.6375	2953	0.463*
"	900	0.0289	6708	23.2**
Magnesium hydroxide	150	0.4956	670	0.135*
Nickel hydroxide	150	0.1222	1797	1.47*
"	600	0.1092	22098	20.2**

Note:*Adhesion water, ** bonded water

4. Oxides**Key Points**

Metallic oxides generally react with the iodine in Karl Fischer reagent in accordance with the following formula. In particular, alkaline metal and alkaline earth oxides (strong basicity) react quantitatively and rapidly.



A number of substances, such as magnesium oxide, zinc oxide, silver (I)oxide, mercury (I) oxide and copper (I) oxide, react with Karl Fischer reagent in accordance with the formula below.



Manganese dioxide reacts with Karl Fischer reagent as shown below.

Lead dioxide and red lead cause similar reactions.

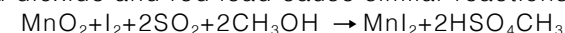

As a result, direct titration is not possible and moisture content is measured using the moisture vaporization method.

For measurement using moisture vaporization, the heating temperature for normal adhesion water is set at 100-200°C.

[Examples of Measurement]**(1) Moisture vaporization - Coulometric titration**

Reagents used: Aquamicon AX (or AS)
Aquamicon CXU

150ml
10ml

Substance	Heating temperature(°C)	Sample quantity (g)	Measurement value (µg)	Moisture content (%)
Zinc oxide	200	2.1892	1715	783ppm
Aluminum oxide	200	1.4522	1801	0.124
"	700	0.7433	1581	0.213
Antimony oxide	150	1.9930	0211	106ppm
Cadmium oxide	250	0.7301	0228	312ppm
Gadolinium oxide	800	0.1192	0977	0.820
Calcium oxide	100	1.3610	0261	192ppm
"	800	0.2526	1862	0.737
Silicon oxide	250	0.1295	1313	1.01
Copper (I) oxide	110	0.4958	0654	0.132
"	700	0.3140	4734	1.51
Copper (II) oxide	700	0.6090	2366	0.389
Titanium oxide	300	0.3858	3691	0.957
Nickel oxide	250	0.9014	1135	0.126
Bismuth oxide	100	2.5479	0182	71ppm
Magnesium oxide	130	0.2773	0906	0.327
Manganese oxide	750	0.1382	6650	4.81
Iron (III) oxide	200	0.5168	1460	0.283
"	500	0.5353	1729	0.323
Red iron oxide	200	0.4209	1751	0.416
"	700	0.4079	2076	0.509

5. Halides (halogenides)**Key Points**

As a general rule, halides do not cause interference and can be measured directly. Also, some halides can be dissolved in titration solvents and titrated with either volumetric or coulometric titration.

Volumetric titration is carried out using a general-purpose dehydrated solvent. If a substance cannot be dissolved or causes interference, the moisture vaporization method is used. Care needs to be taken when taking samples as many of these substances absorb humidity very readily.

Some substances, such as ammonium chloride, sodium chloride, potassium chloride, potassium iodide and cerium iodide, occlude their moisture content during crystallization. The extent of this effect is reported to be 0.1-0.3%. Since these salts generally dissolve readily in formamide, moisture content can be measured using a dehydrated solvent formulated for sugars as the titration solvent.

Reference: Solubility of salts in formamide (g/100g)

NaCl	9.33	NaI	62.7
KCl	6.31	KI	62.5
NH ₄ Cl	11.05		

Alkaline earth halides crystallize as hydrates. Substances that can be measured without major problems include magnesium chloride 6-hydrate, calcium chloride 2-hydrate, strontium chloride 6-hydrate, and barium chloride 2-hydrate. The same is true of bromides and iodides.

Potassium fluoride (anhydride and 2-hydrate) is soluble and can be measured without any difficulty. Calcium fluoride is insoluble and its moisture content cannot be measured through direct titration.

Similar measurement procedures can be used for substances such as aluminum chloride 6-hydrate, manganese (II) chloride 4-hydrate, cobalt chloride 6-hydrate, cadmium chloride 2.5-hydrate and tin (IV) chloride 5-hydrate. However, care is needed with the following salts as their water does not react with iodine on a mole-for-mole basis.

With copper (II) chloride 2-hydrate, only 1.5 mole of water is measured.



With iron (III) chloride 6-hydrate, only 5.5 mole of water can be measured.

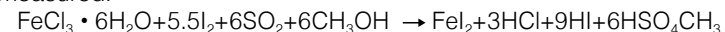

Tin (II) chloride 2-hydrate is a powerful reducing agent. Direct measurement is not possible as it reduces the iodine in Karl Fischer reagent.

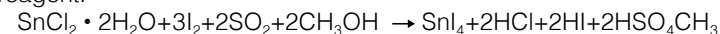

[Examples of Measurement]**(1) Volumetric titration**

Reagents used: Karl Fischer Reagent SS-Z (or SS) 25-50ml
Dehydrated Solvent GEX (or MS)

Substance	Dehydrated solvents	Sample quantity (g)	Measurement value (mg)	Moisture content (%)
Aluminum chloride 6-hydrate	General-use	0.0331	15.17	45.8
Potassium chloride	"	0.5178	1.37	0.26
Magnesium chloride 6-hydrate	"	0.0554	30.04	54.2
Magnesium chloride anhydride	"	0.6703	3.01	0.45
Lithium chloride	"	0.1004	5.11	5.09
Manganese chloride	"	0.0759	27.94	36.8
Strontium chloride	"	0.0412	16.75	40.6
Vanadium chloride	"	0.0766	18.10	23.6
Barium chloride	"	0.5933	86.92	14.7
Lithium chlorate	"	0.1053	13.77	13.1
Dried lithium chlorate	"	0.0783	2.13	2.72
Sodium iodide	"	3.3707	1.63	0.048

(2) Coulometric titration

Reagents used: Aquamicon AX (or AS) 100ml
Aquamicon CXU 5ml

Substance	Sample quantity (g)	Measurement value (μg)	Moisture content (%)
Aluminum chloride 6-hydrate	0.0166	7490	45.1
Manganese chloride	0.1607	700	0.436
Lithium chloride	0.0932	4780	5.13
Sulfur hexafluoride	10.29	230	22ppm

(3) Moisture vaporization - Coulometric titration

Reagents used: Aquamicon AX (or AS) 150ml
Aquamicon CXU 10ml

Substance	Heating temperature(°C)	Sample quantity (g)	Measurement value (μg)	Moisture content (%)
Potassium chloride	100	0.9903	1056	0.107
"	750	1.0021	3044	0.304
Lithium chloride	200	0.1035	5117	4.94
Cesium iodide	200	9.5975	18	2ppm
Sodium iodide	400	2.9079	1510	519ppm
Barium fluoride	800	0.5323	291	547ppm
Aluminum fluoride	800	0.6244	55	88ppm
Zinc fluoride	500	0.8577	596	695ppm

6. Carbonates, Bicarbonates**Key Points**

Direct measurement is not possible with carbonates and bicarbonates as they react with Karl Fischer reagent and cause interference. The degree of interference depends on the solubility of each substance. For example, alkaline metal carbonates and bicarbonates react as shown in the formulae below.

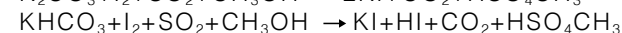
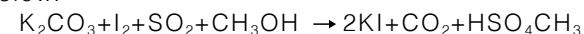

Direct measurement is possible with calcium carbonate. Since it does not dissolve in dehydrated solvent it is dispersed and the moisture content extracted. This is only possible with volumetric titration.

Direct measurement is not possible with sodium bicarbonate and the moisture vaporization method is also unsuitable as the substance releases water when heated. In general, for carbonates that are stable when heated, the moisture content is measured using the moisture vaporization method.

[Examples of Measurement]**(1) Volumetric titration**

Reagents used: Karl Fischer Reagent SS-Z (or SS) 25-50ml
Dehydrated Solvent GEX, OL II (or MS, CM)

Substance	Dehydrated solvent	Sample quantity (g)	Measurement value (mg)	Moisture content (%)
Calcium carbonate	General-use	1.0272	1.86	0.181
Calcium carbonate	Oil-type	1.0053	1.63	0.162

Note:The end point was more stable with an oil-type dehydrated solvent.

(2) Moisture vaporization - Coulometric titration

Reagents used: Aquamicon AX (or AS) 150ml
Aquamicon CXU 10ml

Substance	Heating temperature(°C)	Sample quantity (g)	Measurement value (µg)	Moisture content (%)
Calcium carbonate	100	0.1223	623	0.509
"	600	0.0975	1554	1.58
Potassium carbonate	200	0.6278	1712	0.273
Sodium carbonate	180	0.2004	4099	2.05
Barium carbonate	300	0.6761	805	0.119
"	700	0.8437	1103	0.131
Basic magnesium carbonate	250	0.0249	3605	14.5
Manganese carbonate	110	0.0334	1723	5.16
"	600	0.0466	3699	7.94

Measuring the moisture content of sodium bicarbonate

Sodium bicarbonate is used in fire extinguishers and various other applications. Even trace amounts of moisture can lead to problems during storage or use. It is difficult to measure moisture content accurately using the conventional sulfuric acid desiccator method, so the Karl Fischer titration method is used together with a moisture extraction-correction technique as described below.

Approximately 100g of sample is taken in a 500ml separating funnel. To this, 130ml of dehydrated methanol is added. The mixture is stirred well and then left to stand.

When the sample and methanol have separated, 50ml of liquid is extracted and placed in the titration flask of a Karl Fischer titration system, and titrated. The small quantity of sample dissolved in the extracted liquid is titrated by neutralization titration, and the moisture content is determined by correcting the Karl Fischer titration result.

Reference:N.G. Leavitt, C.B. Robert: Anal.Chem., 26,1367 (1954).

7. Sulfates, Sulfites

Key Points

Differences in reactivity to Karl Fischer reagent mean that the choice of direct titration method must be made with reference to the individual substance. In most cases we recommend the measurement of moisture content using the moisture vaporization method. Sulfates crystallize as hydrates. In general, hydrates with six or more molecules of water of crystallization dissolve in methanol and remain in solution during titration. This means that they can be measured directly using a general-purpose solvent. Some examples of this type of substance are listed below.

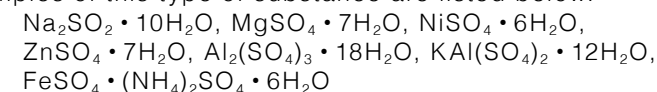

Water is strongly bonded in zinc sulfate 1-hydrate and manganese sulfate 1-hydrate and cannot be measured. Karl Fischer titration cannot be used for calcium sulfate 2-hydrate at normal room temperatures as the water is released very slowly. Total moisture content can be measured by using the moisture vaporization method at a temperature above 200°C. Copper sulfate causes interference by oxidizing hydrogen iodide, the reactive substance in Karl Fischer reagent. This reaction frees 0.5 moles of iodine.

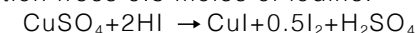

As the resulting free iodine acts as a reagent, the measurement results will be low. In general, the weakly acidic salts of alkaline metals react in the same way as oxides.

Sulfites and pyrosulfites react quantitatively. Sodium sulfite and sodium pyrosulfite react as shown in the following formulae.

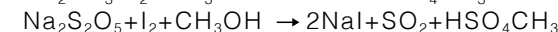
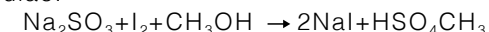

Accordingly, the moisture vaporization method is used with these salts.

[Examples of Measurement]**(1) Moisture vaporization - Volumetric titration**

Reagents used: Karl Fischer Reagent SS-Z (or SS) 50-100ml
Dehydrated Solvent GEX (or MS)

Substance	Heating temperature(°C)	Sample quantity (g)	Measurement value (mg)	Moisture content (%)
Sodium metabisulfite	150	0.1926	11.39	5.91
Potassium metabisulfite	150	0.2215	3.85	1.74
Gypsum	250	0.2060	14.76	7.17

(2) Moisture vaporization - Coulometric titration

Reagents used: Aquamicon AX (or AS) 150ml
Aquamicon CXU 10ml

Substance	Heating temperature(°C)	Sample quantity (g)	Measurement value (µg)	Moisture content (%)
Sodium dithionite (Sodium hydrosulfite)	200	0.4796	2671	0.557
Sodium sulfite	250	4.0301	247	61ppm
Aluminum sulfate				
100°C dried	700	0.0229	8787	38.4
200°C dried	700	0.0515	8139	15.8
Sodium sulfate	250	3.1305	375	120ppm
Calcium sulfate	200	0.0521	3310	6.35
"	600	0.0684	4337	6.34
"	900	0.0612	3868	6.32

8. Other Salts**Key Points**

Some salts react with Karl Fischer reagent and others do not. Direct measurement is possible with salts that do not react with Karl Fischer reagent and that can be dissolved or dispersed in a titration solvent. As a general rule, moisture content can be determined easily by using the moisture vaporization method. First, however, it is necessary to take the heating temperature into consideration because of the need to check for such factors as intramolecular dehydration. Procedures for the various types of salts are described below.

Nitrates can be measured directly using volumetric titration. A generalpurpose dehydrated solvent is used. Depending on the solubility of the substance, a solvent formulated for sugars may be used. Examples of substances for which this method is suitable include ammonium nitrate, sodium nitrate, potassium nitrate, chromium nitrate, cobalt nitrate and mercury (I) nitrate.

Sodium nitrite cannot be measured directly as it reacts quantitatively with Karl Fischer reagent as shown in the following formula.



Chromates and bichromates also react with Karl Fischer reagent, but the reactions are not quantitative. Potassium permanganate is insoluble and will not react. Sodium tetraborate produces a similar reaction with boric acid, and direct measurement is not possible.

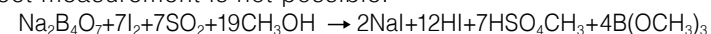

Sodium arsenite reacts in the same way with oxides (anhydrous arsenites.)



Primary phosphates can be measured directly using volumetric titration.

The behavior of secondary phosphates reflects their weak basicity, but they do not cause any significant interference. Tertiary phosphates cause interference because of their strong basicity and they must be neutralized with acid before Karl Fischer titration.

[Examples of Measurement]**(1) Volumetric titration**

Reagents used: Karl Fischer Reagent SS-Z (or SS)
Dehydrated Solvent GEX (or MS) 25-50ml

Substance	Dehydrated solvent	Sample quantity (g)	Measurement value (mg)	Moisture content (%)
Di-ammonium hydrogen phosphate	General-use	0.1511	3.94	2.61
Sodium nitrate	"	2.1116	2.46	0.116*
Sodium nitrate	Sugar-type	2.2079	2.73	0.124**

Note:* Partially insoluble. ** Soluble

(2) Moisture vaporization - Volumetric titration

Reagents used: Karl Fischer Reagent SS-Z (or SS)
Dehydrated Solvent GEX (or MS) 50-100ml

Substance	Heating temperature(°C)	Sample quantity (g)	Measurement value (mg)	Moisture content (%)
Sodium metasilicate	200	0.1039	41.52	40.0

(3) Moisture vaporization - Coulometric titration

Reagents used: Aquamicon AX (or AS) 150ml
Aquamicon CXU 10ml

Substance	Heating temperature(°C)	Sample quantity (g)	Measurement value (µg)	Moisture content (%)
Aluminum nitrate	700	0.0200	8853	44.3
Sodium nitrate	130	2.0903	721	345ppm
"	400	0.4948	1501	0.303
Sodium tripolyphosphate	100	1.1821	1555	0.132
"	150	1.1219	6044	0.539
"	250	1.1523	End point	not reached
Di-ammonium hydrogen phosphate	110	0.0960	2568	2.68
Tri-sodium phosphate	150	0.0342	18449	53.9
Magnesium hypophosphite	180	0.0338	13640	40.4

9. Inorganic Gases**Key Points**

The moisture content of non-condensing gases, such as nitrogen, oxygen and hydrogen, is captured by passing the sample gas through a titration solvent or electrolyte.

Karl Fischer titration is then carried out. It is necessary, therefore, to obtain and assemble equipment which includes pipes for the sample gases and gas meters. Metal pipes should be used at the injection ports. Pipes made of vinyl chloride or other plastics should be avoided as these absorb atmospheric moisture.

For volumetric titration, an absorption solution is prepared by mixing a general-use dehydrated solvent with propylene glycol in a ratio of 3:1.

For short periods, general-use dehydrated solvent can be used alone. In such cases, changes in the quantity of the titration solvent, caused by volatilization, must be monitored carefully.

For substances with low moisture content, accurate measurements can be obtained by using a low-titer Karl Fischer reagent.

Because of the minute amounts of moisture in inorganic gases, we recommend coulometric titration.

[Examples of Measurement]**(1) Volumetric titration**

Place 150ml of dehydrated solvent in a titration flask. Titrate the Karl Fischer reagent to the end point to remove all moisture. Next pass the sample gas through the dehydrated solvent in the titration flask at a rate of 0.2-0.5l/min. The flow of gas should be measured using a gas meter. Stop the flow of gas (A) after the amount of water absorbed into the dehydrated solvent has reached 5-50mg. Titrate (Bml) immediately using a Karl Fischer reagent with a known titer (Fmg/ml). Calculate the moisture content (W%) according to the following formulae.

$$W (\text{Vol}\%) = \frac{B \times F \times 1.244 \times \frac{760}{P} \times \frac{(273+t)}{273}}{A \times 1000} \times 100$$

$$W (\text{Wt}\%) = \frac{B \times F}{A \times \frac{P}{760} \times \frac{273}{273+t} \times \frac{M}{22.4}} \times 100$$

Here,

P: Atmospheric pressure (mmHg) at time of measurement

t: Temperature of gas at time of measurement ($^{\circ}\text{C}$)

M: Molecular weight of sample gas

Sample gas	Sample quantity (l)	Titration quantity (ml)	Moisture content (v/v%)
Hydrogen	10.0	2.21	0.030
Nitrogen	30.0	0.38	0.0017
Oxygen	30.0	3.09	0.014

Note: Using Karl Fischer Reagent SS (titer: 1mg/ml)

Reference: Muroi, K., Bunseki Kagaku [Analytical Chemistry] 10, 847 (1961).

"Determination of a Micro-quality of Water in Gaseous Sample by the Karl Fischer Method"

(2) Coulometric titration

Inject 150ml of Aquamicon AX into the anode chamber of an electrolytic cell fitted with a gas adapter. Inject 10ml of Aquamicon CXU into the cathode chamber. Apply an electrolytic current to the Aquamicon AX while stirring,

and use coulometric titration to remove all water from the system. Next, pass the sample gas into the electrolytic cell via the gas adapter at a rate of 0.3- 0.5l/min. Use a gas meter to measure the volume of the gas flow. Stop the flow of gas after the amount of water absorbed into the Aquamicon AX has reached 0.1-5mg. Immediately, carry out coulometric titration to the end point and calculate the moisture content.

Sample gas	Sample quantity (l)	Titration quantity (μg)	Moisture content (v/vppm)
Nitrogen	20	475	31.6
Oxygen	20	171	11.4
Hydrogen	20	99	6.8
Argon	20	28	1.9

Chapter III: Applications - 2

Chapter III: Applications - 2

In this section we provide some actual examples of the use of Karl Fischer titration with chemical products, other industrial products, foodstuffs, pharmaceuticals and other substances.

III-1. Industrial Products

Most general chemical and industrial products consist of organic or inorganic compounds, either singly or as mixtures. This means that for many products moisture content can be determined using Karl Fischer titration. Because of the wide variety of substance characteristics and forms, however, it is important to choose the most appropriate measurement method with reference to the substances that make up each product. In this chapter we give actual examples of moisture measurement for as many products as possible.

1. Fertilizers

Key Points

Single-salt fertilizers, such as ammonium sulfate, ammonium chloride, ammonium nitrate, urea and potassium chloride, can be either dissolved or dispersed in a general-use dehydrated solvent for Karl Fischer titration. Other substances, such as synthetic fertilizers containing urea, should be dispersed in a general-use dehydrated solvent in preparation for Karl Fischer titration. The moisture content of synthetic fertilizers that do not contain urea can be measured using the moisture vaporization method.

Coulometric titration can be used only in conjunction with moisture vaporization.

Moisture vaporization is sometimes effective with fertilizers, but account must be taken of the fact that some ingredients in compound fertilizers, such as urea, ammonium phosphate and single superphosphate, break down when heated to certain temperatures.

[Examples of Measurement]

(1) Volumetric titration

Reagents used: Karl Fischer Reagent SS-Z (or SS)

Dehydrated Solvent GEX (or MS)

25-50ml

Substance	Sample quantity(g)	Measurement value (mg)	Moisture Content (%)	Heating loss method (%)
Ammonium sulfate	5.1321	0.70	136ppm	0.016
Ammonium chloride	5.0541	1.80	356ppm	0.044
Sodium nitrate	2.5784	15.60	0.605	0.59
Ammonium nitrate	5.0635	5.01	0.099	0.080
Urea	2.5089	1.40	558ppm	0.060
Potassium chloride	2.5113	8.80	0.35	0.36
Urea+ammonium nitrate	2.5213	23.75	0.942	0.94
Urea+ammonium sulfate	2.5055	33.75	1.35	1.30
+ammonium phosphate				
Chemical fertilizer	0.4920	14.63	2.97	2.23
High-grade chemical fertilizer	0.1500	5.34	3.56	3.30

(2) Moisture vaporization - Coulometric titration

Reagents used: Aquamicon AX (or AS) 150ml
 Aquamicon CXU 10ml

Substance	Heating Temperature (°C)	Sample Quantity(g)	Measurement Value (µg)	Moisture Content (%)
Ammonium sulfate	100	0.6294	2827	0.449
Chemical fertilizer	100	0.0998	2000	2.00
High-grade chemical fertilizer	100	0.0929	3539	3.81

2. Agricultural Chemicals**Key Points**

Direct Karl Fischer titration is possible for substances that can be dissolved in dehydrated solvent. Samples of main ingredients and other products can be dissolved in a general-use dehydrated solvent and titrated directly. Powders that include fillers and other substances should be stirred for a while in a general-use dehydrated solvent. The moisture content can then be fully extracted and titrated. Alternatively, the moisture vaporization method can be used.

However, chloropicrin is oxidative and causes interference by freeing iodine.

Substances that may react with Karl Fischer reagent include copper powders, mercury powders, copper-mercury powders, zineb granules and arsenate-lime powders. The normal moisture vaporization method is suitable for agricultural chemicals in solid form. Adhesion water can be measured at 100-150°C. The heating temperature should be determined in accordance with the individual substance.

[Examples of Measurement]**(1) Volumetric titration**

Reagents used: Karl Fischer Reagent SS-Z (or SS) 25-50ml
 Dehydrated Solvent GEX (or MS)

Substance	Sample Quantity(g)	Measurement value (mg)	Moisture Content (%)	Remarks
Chloropicrin	3.3387	0.31	0.0093	Turns brown immediately after end point
Kitazine-P	1.0875	2.27	0.209	
Insecticide	5.1263	3.51	685ppm	
Captan	0.2394	6.64	2.77	
Namekat	0.1437	5.69	3.96	Insoluble
Powdered sulfur	1.0222	5.93	0.580	

(2) Coulometric titration

Reagents used: Aquamicon AX (or AS) 100ml
 Aquamicon CXU 5ml

Substance	Sample quantity (g)	Sample Quantity (µg)	Moisture Content (%)
IBP*	1.0260	2210	0.215

*:O,O-Diisopropyl-S-benzylthiophosphate

(3) Moisture vaporization - Coulometric titration

Reagents used: Aquamicon AX (or AS) 150ml
Aquamicon CXU 10ml

Substance	Heating Temperature (°C)	Measurement Value(g)	Measurement Value(µg)	Moisture Content (%)
TPN (Daconil)	100	0.4867	241	495ppm
Zineb (Diefar)	110	0.1021	1459	1.43
Namekat	110	0.1314	6606	5.03
Captan	110	0.0679	1914	2.82
Bryeslin powder	150	0.1109	4822	4.35

Captan: N-Trichloromethylthio-4-cyclohexene-1,2-dicarboximide

TPN: Tetrachloroisophthalonitrile

Zineb: Zinc ethylenebisdithiocarbamate

3. Glass/Ceramics

Key Points

Because glass, ceramics and similar substances do not dissolve in organic solvents, both volumetric titration and coulometric titration are used in combination with moisture vaporization.

The heating temperature and other conditions for moisture vaporization must be determined with reference to the type of sample. Particular care is required with glass as it will melt at certain temperatures and adhere to the sample boat used in the moisture vaporization method.

Up to about 600°C, adhesion can be stopped if the boat is covered with aluminum foil.

Direct titration is not possible with cement. The moisture content of cement is chemically bonded, while the oxides in cement cause interference by reacting with Karl Fischer reagent to produce water. The usual method is to carry out moisture vaporization at 800-1,000°C, followed by Karl Fischer titration.

[Examples of Measurement]

(1) Volumetric titration

Reagents used: Karl Fischer Reagent SS-Z (or SS) 25-50ml
Dehydrated Solvent GEX (or MS)

Substance	Sample quantity(g)	Measurement Value (mg)	Moisture Content (%)	Vaporization method(%)
Porous glass powder	0.1589	2.50	1.56	1.55

(2) Moisture vaporization - Volumetric titration

Reagents used:Karl Fischer Reagent SS-Z (or SS) 50-100ml
Dehydrated Solvent GEX (or MS) + PG (3:1)

Substance	Heating temperature (°C)	Sample quantity (g)	Measurement Value (mg)	Moisture Content (%)
Hydrated cement	700	0.1291	19.85	15.3

(3) Moisture vaporization - Coulometric titration

Reagents used: Aquamicon AX (or AS) 150ml
Aquamicon CXU 10ml

Substance	Heating temperature (°C)	Sample quantity(g)	Measurement Value (µg)	Moisture Content (ppm)
Glass wool	200	0.5127	196	382
Lead glass (powder)	400	0.7471	811	0.109%
Fluorine glass	700	0.9856	79	80
Phosphate glass	800	0.2757	285	0.103%
Porous glass (powder)	300	0.2062	3199	1.55%
Sealer	800	2.2730	339	149
Glass	600	1.0121	34	34
Ceramics (powder)	130	2.5429	2974	0.117%
IC ceramics	800	6.7010	222	33
Cement	800	0.3102	2219	0.715%
Cellite (dried)	180	0.1721	128	743

4. Liquefied Petroleum Gases

Key Points

Liquefied petroleum gases, such as propane and butane, can be added directly to dehydrated solvents or electrolytes and subjected to Karl Fischer titration, using either the volumetric or coulometric methods. Coulometric titration is most suitable, since liquefied petroleum gases usually contain only trace amounts of moisture.

To obtain accurate measurements of moisture content, it is important to add the sample in the liquid phase. In particular, allowance must be made for a marked tendency for fluctuations in the moisture content of samples at around the 50ppm level. Be sure to inject the entire sample into the sampling bottle. For details of the methods used, refer to the LPG Testing Method Standards of the Japan LPG Association.

Reference: Muroi, K. et al., "Rapid Determination of Water in LPG by KarlFischer Method" J. Japan Petroleum Institute 11, 440 (1968).

Sampling Method

Liquid-phase samples are obtained as follows.

- (1) Place the canister containing the gas upside-down or on an angle. Connect a high-pressure sampling bottle to the canister outlet using a hose designed for this purpose (Figure 22).
- (2) Open valves A and B of the sampling bottle. Next, gradually open the valve on the canister, allowing a small amount of the gas to vaporize. Release the gas through the sampling bottle.
- (3) Close valve B, and open the valve on the canister to release the sample into the sampling bottle.

Note: The sample can be moved into the sampling bottle by opening and closing valve B, repeatedly. Do not fill the bottle completely with liquid sample. Always keep the sample below 80% of the volume and leave some vapor space.

- (4) Close valve A and the valve on the canister. Remove the hose. Weigh the sampling bottle, and then attach a syringe needle to valve B (Figure 21).

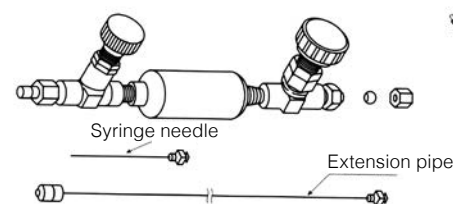

Figure 21: Sampling bottle and hose

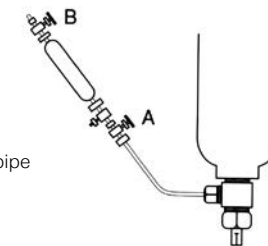

Figure 22: Obtaining a sample from a gas canister

Titration Method

Coulometric titration (or volumetric titration) is carried out as follows.

- (1) First place 150ml of anolyte (or 100ml of general-use dehydrated solvent) in an electrolytic cell and use coulometric titration (or Karl Fischer Reagent SS-X) to remove all moisture.
- (2) Introduce the syringe needle through the side port of the electrolytic cell (or titration flask) until it reaches the bottom of the cell (or titration flask), as shown in Figure 23.

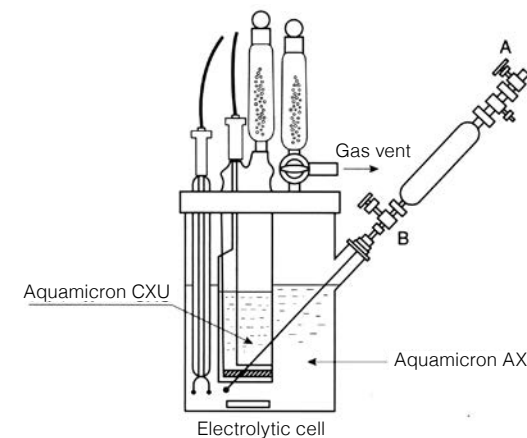

Figure 23: Injecting the sample (coulometric titration)

- (3) Gradually open valve B while stirring the analyte (or general-use dehydrated solvent). Inject the sample for 10-15 minutes (at a rate of about 1g/min.).

Note:The sample will gasify as it is injected and it will escape through the upper vent valve into a draft chamber, or to the outside air.

- (4) Withdraw the syringe from the sampling bottle.
 (5) Weigh the sampling bottle. Subtract this weight from the weight before the injection of the sample to determine the weight of the sample.
 (6) Titrate the moisture absorbed into the analyte (or general-use dehydrated solvent) to the end point, using coulometric titration (volumetric titration).
 (7) Calculate the moisture content using the following formulae.

For coulometric titration:

$$\text{Moisture content (ppm)} = \frac{\text{measurement value } (\mu\text{g})}{\text{sample quantity (g)}}$$

For volumetric titration

$$\text{Moisture content (ppm)} = \frac{\text{Titration volume(ml)} \times \text{Titer(mgH}_2\text{O/ml)}}{\text{sample quantity (g)} \times 1000} \times 100$$

[Examples of Measurement]

(1) Volumetric titration

Reagents used: Karl Fischer Reagent SS-Z (or SS) 100ml
 Dehydrated Solvent GEX (or MS)

Substance	Sample quantity(g)	Titration quantity (mg)	Moisture content (ppm)
LPG	25.1	1.40	56
Propane	29.0	1.11	38
Methyl chloride	18.3	4.95	271
Vinyl chloride	15.7	7.41	475
Sulfur dioxide	53.1	17.6	331
Aerosol	27.4	1.18	43

(2) Coulometric titration

Reagents used: Aquamicon AX (or AS) 150ml
 Aquamicon CXU 10ml

Substance	Sample quantity(g)	Titration quantity (μg)	Moisture content (ppm)
LPG	23.24	253	11
Ethylene	40.06 L	55	1.7
Propane	6.50	280	43
Butadiene	16.63	120	7.2
Flon gas R113	7.97	234	29
Spray cans	6.26	1008	161

5. Coals, Tars

Key Points

The moisture content of coals is normally measured using a moisture vaporization system. Measurements can be obtained using either volumetric or coulometric titration.

Tars are subjected to Karl Fischer titration using the moisture vaporization system designed for oils.

[Examples of Measurement]

(1) Volumetric titration

Reagents used: Karl Fischer Reagent SS-Z (or SS)
 Dehydrated Solvent GEX, OL II (or MS, CM) 25-50ml

Substance	Dehydrated solvents	Sample Quantity(g)	Measurement Value (mg)	Moisture Content (%)
Brown coal	General-use	0.0389	4.38	11.3
Coal tar	Oil-type	0.1619	7.30	4.5

(2) Moisture vaporization - Volumetric titration

Reagents used: Karl Fischer Reagent SS-X (or SS)
 Dehydrated Solvent GEX (or MS) + PG (3:1) 50-100ml

Substance	Dehydrated solvents ($^{\circ}\text{C}$)	Sample Quantity(g)	Measurement Value(mg)	Moisture Content (%)
Powdered coal	150	0.1262	5.76	4.56

(3) Moisture vaporization - Coulometric titration

Reagents used: Aquamicon AX (or AS)
Aquamicon CXU

150ml
10ml

Substance	Heating Temperature (°C)	Sample Quantity(g)	Measurement Value(µg)	Moisture Content (%)
Brown coal	110	0.0497	5456	11.0
Powdered coal	130	0.2509	1188	0.473
Coal tar	150	0.1114	4718	4.24
Coke	500	0.0448	1813	4.05
Pitch tar	180	0.4892	335	685ppm

6. Petroleum Products**Key Points**

Karl Fischer titration is an excellent method for the measurement of trace moisture in petroleum products. Karl Fischer titration has been the standard test method for the Petroleum Society since 1976, and it became a Japan Industrial Standard in 1982.

As moisture is generally present only in trace quantities in petroleum products, coulometric titration is presently in widespread use.

Coulometric titration is carried out by adding a sample, such as insulating oil, refrigerating machine oil, transformer oil, kerosene or diesel oil, to an electrolyte.

The sample is added 5-10ml at a time. Though some substances fail to dissolve and may cloud the solution, their moisture content can be measured once they are thoroughly dispersed.

For volumetric titration, the substance is dissolved in a dehydrated solvent formulated for oils. Karl Fischer titration can then be carried out directly. Silicon oils can be titrated directly by adding samples to a ketone-type dehydrated solvent.

Some additives, such as antioxidants, cause interference reactions with Karl Fischer reagent. If lubricants (e.g. gasoline engine oils and diesel engine oils) and other products contain such substances, Karl Fischer titration must be carried out using an oil-type moisture vaporization system.

Dissolve greases that do not contain interference substances in oil-type dehydrated solvent and titrate directly. For those that do contain interference substances, Karl Fischer titration should be carried out indirectly using a moisture vaporization system.

Petroleum products occasionally contain trace amounts of mercaptan or hydrogen sulfide. These react with Karl Fischer reagent. They react quantitatively with iodine on a mole for mole basis, however, so provided that the amount of mercaptan or the hydrogen sulfide content is known, moisture content can be determined accurately through adjustment of the titration result.

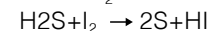
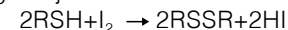

As shown in the above formulae, 1ppm of sulfur in mercaptan or hydrogen sulfide is equivalent to 0.28ppm and 0.56ppm of moisture content, respectively.

[Examples of Measurement]**(1) Volumetric titration**

Reagents used: Karl Fischer Reagent SS-Z (or SS)

Dehydrated Solvent GEX, OL II (or MS, CM) 25-50ml

Substance	Dehydrated solvents	Sample Quantity (g)	Measurement Value (mg)	Moisture Content (ppm)
Industrial gasoline	Oil-type	20.0	0.42	21
Aviation gasoline	"	20.0	0.30	15
Kerosene	"	20.0	1.22	61
Diesel oil	"	20.0	1.66	83
Heavy oil	"	1.0805	27.88	2.58%
Crude oil	"	1.5023	5.41	0.360%
Transformer oil	"	20.0	0.52	26
Refrigerating machine oil	"	20.0	1.24	62
Rust preventive oil	"	20.0	1.80	90
Compressor oil	"	15.0	3.60	240
Air filter oil	"	20.0	1.96	98
Heat treatment oil	"	20.0	1.10	55
Hydraulic oil	"	20.0	0.30	15
Rolling oil	"	20.0	1.08	54
Hydraulic actuation oil	"	20.0	0.84	42
Rotary pump oil	"	30.0	0.30	10
Aviation oil	"	15.0	1.50	100
Fluoride oil	"	20.0	0.34	17
Liquid paraffin	"	30.0	0.45	15
Asphalt	"	5.0	0.95	190
Cutting oil	"	15.0	1.58	105
Grinding oil	"	15.0	2.01	134
Wax	"	0.1001	4.72	4.72%
Brake oil	General-use	1.0555	1.27	0.120%

Substance	Dehydrated solvents	Sample Quantity (g)	Measurement Value (mg)	Moisture Content (ppm)
[Insulating oil]				
Mineral oil	Oil-type	8.8431	0.20	23
Alkylbenzene 2-1	"	8.5784	0.17	20
Alkylbenzene 2-2	"	8.7058	0.55	63
Alkylbenzene 2-3	"	8.3116	0.23	28
Polybutene 3-1	"	8.1933	0.14	17
Polybutene 3-2	"	6.8850	0.19	28
Polybutene 3-3	"	5.9730	0.11	18
Alkyl naphthalene 4-1	"	9.2462	0.15	16
Alkyl naphthalene 4-2	"	9.3594	0.14	15
Alkyl diphenyl ethane	"	9.4135	0.38	40
Silicon oil	Ketone-type	9.6343	0.37	38

(2) Moisture vaporization - Volumetric titration

Reagents used: Karl Fischer Reagent SS-Z (or SS)

Dehydrated Solvent GEX (or MS) + PG (3:1) 50-100ml

Substance	Heating Temperature (°C)	Sample Quantity (g)	Measurement Value (mg)	Moisture Content (%)	
Gasoline engine oil	150	4.3793	0.66	0.015	
Diesel engine oil	150	5.5145	0.94	0.017	
Marine engine oil	150	5.4998	1.04	0.019	
Marine cylinder oil	150	5.4565	1.91	0.035	
Cap grease	JIS 1-1	120	1.0865	2.39	0.220
	JIS 2-2	140	1.0776	4.20	0.390
Fiber greases	JIS 2-3	140	1.0112	0.39	0.039
	JIS 2-4	140	1.0523	0.43	0.041
Graphite greases	JIS 1-1	140	1.0519	1.89	0.180
	JIS 2-1	120	1.0219	1.11	0.109

(3) Coulometric titration

Reagents used: Aquamicon AX (or AS)

Aquamicon CXU

100ml

5ml

Substance	Sample Quantity(g)	Measurement Value (µg)	Moisture Content (ppm)
Gasoline	3.9353	351	89
Naphtha	0.7280	117	161
Kerosene	0.7940	27	34
Heavy oil	4.4103	286	65
Rolling oil	4.3029	233	54
Aviation oil	2.5869	270	104
Refrigerating machine oil	2.4350	101	42
Actuation oil	4.2943	387	90
Brake oil	2.9758	904	304
Liquid paraffin	8.6600	130	15
Electric insulating oils	4.1460	77	19
Alkylbenzene	4.3132	73	17

(4) Moisture vaporization - Coulometric titration

Reagents used: Aquamicon AX (or AS)
Aquamicon CXU

150ml
10ml

Substance	Heating Temperature (°C)	Sample Quantity(g)	Measurement Value (µg)	Moisture Content (ppm)
Diesel oil	130	4.0973	241	59
Heavy oil	110	4.4278	290	66
C heavy oil	150	0.3820	2188	0.573%
Mineral oil	130	4.5434	273	60
Turbine oil	130	8.4001	296	35
Rolling oil	110	4.3029	233	54
Aviation oil	130	3.3879	328	97
Engine oil	130	0.9133	908	994
Gasoline engine oil	180	4.6133	168	36
Diesel engine oil	130	4.3132	1298	301
Gear oil	130	2.6322	244	93
Cutting oil	150	1.7824	134	75
Actuation oil	130	4.2394	98	23
Grinding oil	150	1.7166	186	108
Turbine oil	130	4.4632	149	33
Brake fluid	150	2.9758	904	304
Hydraulic oil	130	4.3793	392	90
Rust preventive oil	130	1.7590	532	303
Machine oil (paraffin)	130	4.3941	263	60
Machine oil (naphthene)	130	4.5122	274	61
Crude oil	130	0.4156	1506	0.362%
Wax	150	0.7235	8	11

7. Plastics

Key Points

Plastics reach high temperatures during the molding process and trace amounts of moisture can cause bubbling or seriously affect the performance of a plastic by reducing its molecular weight through pyrolysis. This means that moisture management is a very important aspect of the drying processes for plastics. Karl Fischer titration is the ideal method for measuring trace moisture content in plastics. The moisture vaporization method permits accurate and relatively fast (10- 30 minutes) determination of moisture content. When using the moisture vaporization method, it is important to set the heating temperature with reference to the type of plastic. The optimal temperature range must be determined for each plastic. The generally accepted view is that plastics should be heated to around melting point. Figure 24 provides guidelines on the appropriate heating temperatures.

[If the analytical result is high]

If the heating temperature is too low, moisture vaporization will be delayed and the analytical time will be longer. The measurement process may end before the moisture has been vaporized, leading to a low analytical result.

The result may also be low if vaporized moisture is absorbed by additives or degraded plastic constituents that have condensed in the tubes of the moisture vaporization system.

[If the analytical result is high]

Plastics that contain OH bases, such as polyvinyl alcohol, phenol resin and polyvinyl acetate, may produce high readings if the heating temperature is too high. It may be impossible to complete titration in some cases. Such phenomena appear to be caused by the formation of water through heating.

Moisture content of urea resin cannot be measured normally at temperatures above 120°C because ammonia produced through the breakdown of urea resins reacts with iodine. Melamine resins appear to cause interference in the same way.

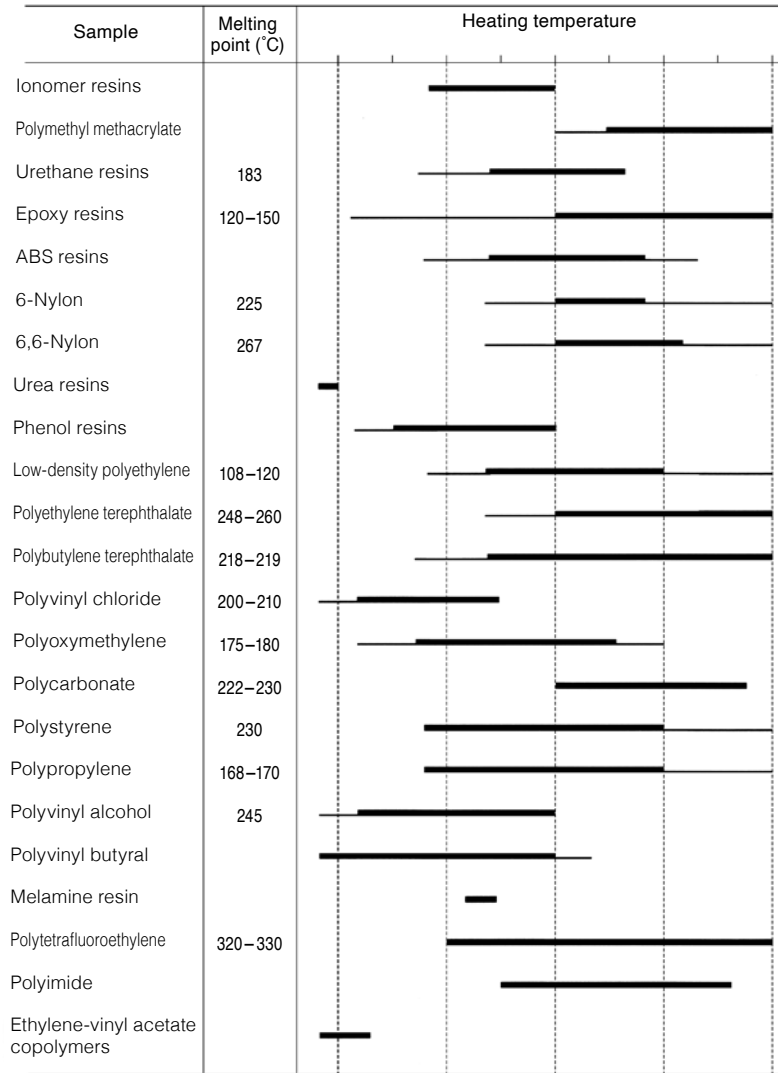

Figure 24: Optimal Moisture Vaporization Temperature Ranges for Plastics

Reference: Kato, H. et al.: Kobunshi Kako, 35, 584 (1986).
 Muroi, K. et al.: Bunseki Kagaku, 11, 351 (1962).

[Examples of Measurement]

(1) Moisture vaporization - Coulometric titration

Reagents used: Aquamicon AX (or AS) 150ml
 Aquamicon CXU 10ml

Substance	Heating Temperature (°C)	Sample Quantity (g)	Measurement Value (µg)	Moisture Content (ppm)
Polyethylene	180	3.7702	67	18
Cross-linked polyethylene	180	1.2786	145	113
Polypropylene	160	2.3185	97	42
Vinyl chloride	130	0.9815	412	420
Vinyl acetate	130	1.5925	1549	973
Ethylene vinyl acetate copolymer	180	0.4743	1005	0.212%
Polyvinyl alcohol	150	0.1392	3739	269
Polyvinyl butyral	180	0.5641	1486	0.263%
Polystyrene	180	2.7896	965	345
Styrol foam	130	0.2892	218	753
Polyester	230	2.4615	512	208
PET	230	4.6003	171	37
PBT	250	1.2020	223	186
Polycarbonate	250	1.0830	972	898
Polyacetal	200	1.5227	2181	0.143%
Phenol resins	200	0.1142	5227	4.58%
6-Nylon	230	0.2211	3007	1.36%
6,6-Nylon	250	0.0492	1200	2.44%
Metacrylic resins	250	1.6017	1337	835
ABS resins	200	0.8455	2073	0.245%
Urea resins	110	0.4898	3587	0.732%
Fluorine resins	160	2.4470	18	7
Epoxy resins	120	0.4142	2360	0.570%
Polyol	150	1.0286	1258	0.122%
Urethane	180	1.4886	3136	0.211%

8. Rubber, Rubber Products, Compounding Agents

Key Points

The qualities of rubber are adversely affected by the presence of moisture in raw materials or in compounding agents. Moisture content can be measured accurately, quickly (10-20 minutes) and conveniently by combining moisture vaporization with coulometric titration.

Hints:

1. The sample should weigh between 0.5g and 1g.
2. The heating temperature for moisture vaporization should be 130-200°C. Direct titration is not possible with vulcanization accelerators and antioxidants as these react with Karl Fischer reagent to release iodine. The moisture content of carbon black cannot be measured through direct titration as the end point cannot be determined.

Reference: Muroi, K. et al.: Journal of Japan Rubber Institute, 52, 61 (1979).

[Examples of Measurement]

(1) Moisture vaporization - Coulometric titration

Reagents used: Aquamicon AX (or AS) 150ml
 Aquamicon CXU 10ml

Substance	Heating Temperature (°C)	Sample Quantity (g)	Measurement Value (µg)	Moisture Content (%)
[Rubber]				
NBR (nitrile-butadiene rubber)	150	0.8001	2554	0.319
SBR (styrene-butadiene rubber)	150	1.2264	475	387ppm
CR (chloroprene rubber)	130	1.4352	1148	800ppm
Butyl rubber	150	1.9435	894	460ppm
Silicon rubber	200	0.1657	2081	1.25
EPR (ethylene propylene rubber)	180	3.4106	1001	293ppm
Natural rubber	150	0.6374	1734	0.272
[Rubber products]				
Rubber caps	150	0.6121	3158	0.516
Power cable rubber	130	0.0977	871	0.892
Oil seal rubber	150	0.3228	1661	0.515
Tire rubber	200	0.5031	2635	0.524
Silicon rubber	200	0.4937	1199	0.243

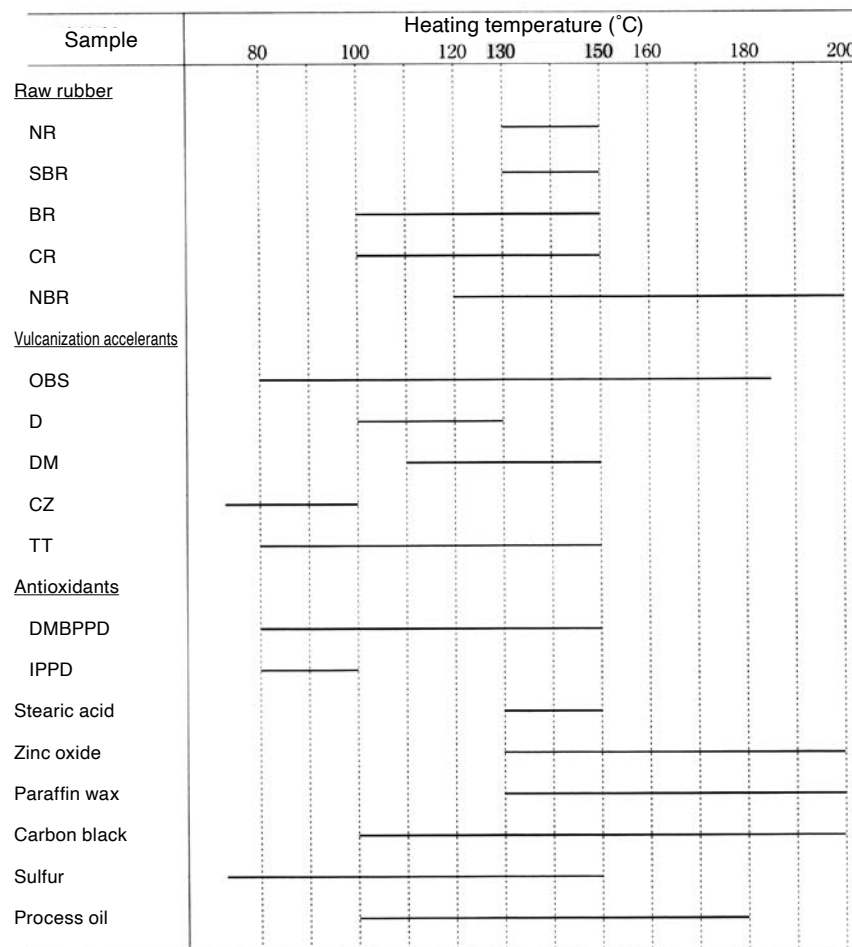

Figure 25: Optimal Heating Temperature Range for Raw Rubber and Compounding Agents

Reference: Muroi, K. et al.: Journal of Japan Rubber Institute, 52, 61 (1979).

9. Fibers, Papers

Key Points

Because samples of fibers and paper do not dissolve in dehydrated solvent, moisture content is measured using moisture vaporization followed by Karl Fischer titration (volumetric or coulometric).

A heating temperature of 130-150°C is appropriate for moisture vaporization. Moisture content in samples of these substances typically reaches several per cent. The following guidelines are suggested for sample quantities.

- 1) Volumetric titration: 0.5g
- 2) Coulometric titration: 0.05-0.1g

Reference: Muroi, K. et al., "Determination of Water Content in Electric Insulating Papers by the Karl Fischer Method" in Bunseki Kagaku 30, 624 (1981).

[Examples of Measurement]

(1) Moisture vaporization - Volumetric titration

Reagents used: Karl Fischer Reagent SS-Z (or SS)
Dehydrated Solvent GEX (or MS) + PG (3:1) 50-100ml

Substance	Heating Temperature (°C)	Sample Quantity (g)	Measurement Value (mg)	Moisture Content (%)
Bakelite paper	150	0.5111	34.70	6.80
Condenser paper	150	0.4955	36.74	7.42
Pressed board paper	150	0.6646	49.29	7.42
Filter paper	230	0.1700	8.82	5.19

(2) Moisture vaporization - Coulometric titration

Reagents used: Aquamicon AX (or AS) 150ml
Aquamicon CXU 10ml

Substance	Heating Temperature (°C)	Sample Quantity (g)	Measurement Value (µg)	Moisture Content (%)
Kraft paper	150	0.0663	3840	5.79
Synthetic paper	150	0.0563	2910	5.17
Woodfree paper	150	0.0201	722	3.59
Machine-made paper	150	0.0948	4793	5.06
Photocopy paper	150	0.0665	3099	4.66
Oil paper	180	0.0526	3160	6.01
Paper tape	150	0.2057	4892	2.38
Cellotape	150	0.0741	6975	9.41
Copy paper	150	0.8160	2553	0.313
Cellulose (paper)	150	0.0500	3057	6.11
Acrylic fibers	110	0.2396	2653	1.07
Polyester	180	0.2177	430	0.198
Chemical fibers	180	0.0497	2596	5.22
Wool	150	0.0838	7225	8.62
Absorbent cotton	150	0.0631	4379	6.94

10. Dyestuff Intermediates

Key Points

Many dyestuff intermediates are solids and must be dissolved in solvents. Most Japanese Industrial Standards stipulate volumetric titration. These standards should be taken into account when setting conditions for the moisture content test methods that should be used with individual compounds.

To raise the solubility of specific substances in the dehydrated solvent used for the volumetric titration, it may be necessary to add other solvents, such as those listed below, to the methanol. It should also be noted that special solvents are sometimes used with amines.

Volumetric titration solvents and the main compounds for which they are used

- 1) Dehydrated Solvent MS (or GEX)
- 2) Dehydrated Solvent CP : anilines, o-anisidines, p-cresidines, p-chloroanilines
CP+acetic acid : p-anisidines, p-phenetidines, m-aminophenols
- 3) Dehydrated Solvent PE : Peri acid

- 4) Dehydrated Solvent MS+pyridine : metanilic acid,
o-toluenesulfonamide, C-acids
- 5) Dehydrated Solvent MS+dichloromethane : nitro compounds,
some chloro compounds

Coulometric titration can be used. However, interference reactions make it unsuitable for some substances (* e.g. anilines and other electrode-reactive substances).

Substances for which coulometric titration cannot be used Anilines, p-anisidines, m-aminophenols, p-chloroanilines, p-toluidines, metanilic acid

[Examples of Measurement]

(1) Volumetric titration

Reagents used: Karl Fischer Reagent SS-Z (or SS)
Dehydrated Solvent OL II, KT (or CM, CP) 25-50ml

Substance	Dehydrated solvents	Sample Quantity(g)	Measurement Value(mg)	Moisture Content(ppm)
p-Toluidines	CP+acetic acid (2:1)	2.9253	0.89	304
p-Anisidines	"	2.0115	0.46	229
p-Phenetidines	"	1.1072	1.68	0.152
m-Aminophenols	"	1.0152	0.29	286
Anthranilic acid	General-use	1.0164	0.11	108
Diphenyl amine	"	8.3429	0.25	30
2-Aminonaphthalene -1-sulfonic acid	"	0.5290	1.62	0.306
Sodium naphthionate	"	0.0593	13.45	22.7
J-acid	"	0.1051	5.88	5.60
Carbonyl J-acid	"	0.2062	6.15	2.98
m-Nitroaniline	"	1.5089	0.95	630
p-Nitrophenol	"	0.9844	11.30	1.15
1-Hydroxy-2-naphthoic acid	"	2.0959	0.54	258
Anilines	Ketone-type	2.1601	1.92	889
5-Amino-2-chlorotoluene)	MS+pyridine (5:1)	1.9911	0.09	45
-4-sulfonate(C-acid)				

(2) Coulometric titration

Reagents used: Aquamicon AX (or AS) 100ml
Aquamicon CXU 5ml

Substance	Electrolyte	Sample Quantity (g)	Measurement Value(µg)	Moisture Content(ppm)
Anthranilic acid	General-use	1.1934	370	310
Diphenyl amine	"	4.0630	104	26
2-Aminonaphthalene-1-sulfonic acid(Tobias acid))	"	0.5500	1721	0.313%
Sodium naphthionate	"	0.0514	11653	22.7%
8-Amino-2-naphthalene sulfonic acid(Peri acid)	"	0.0561	4260	7.59%
m-Aminophenol	Ketone-type	0.4592	117	255

11. Pigments

Key Points

Most pigments are insoluble in titration solvents and cannot be titrated directly. In particular, direct titration should be avoided with inorganic pigments which react with Karl Fischer reagent.

The moisture content of any pigment can be measured quickly (10-30 minutes) and accurately using the conventional drying method based on moisture vaporization. Either volumetric or coulometric titration can be used, depending on the moisture content.

(1) Moisture vaporization - Volumetric titration

Reagents used: Karl Fischer Reagent SS-Z (or SS)
Dehydrated Solvent GEX (or MS) + PG (3:1) 50-100ml

Substance	Heating Temperature (°C)	Sample Quantity (g)	Measurement Value (mg)	Moisture Content (%)
Zinc white	300	3.1135	3.73	0.120
Titanium oxide	200	1.0405	4.16	0.400
Prussian blue	200	0.4002	22.17	5.540
Red iron oxide	300	3.0021	10.21	0.340
Chrome yellow	300	2.9988	8.40	0.280
Aluminum powder	400	5.0211	1.00	199ppm
Antimony oxide	300	3.5011	3.85	0.110
Calcium carbonate	100	2.1111	10.77	0.510
"	600	1.0050	16.18	1.61
Barium carbonate	500	3.1009	4.03	0.130

(2) Moisture vaporization - Coulometric titration

Reagents used: Aquamicon AX (or AS) 150ml
 Aquamicon CXU 10ml

Substance	Heating Temperature (°C)	Sample Quantity(g)	Measurement Value(μg)	Moisture Content (%)
Cuprous oxide	230	0.3651	2959	0.810
"	700	0.1497	1953	1.30
Titanium oxide	200	1.0378	3631	0.350
Yellow pigment	230	0.1949	2028	1.04
Red pigment	200	0.0415	2370	5.71
Barium carbonate	500	3.1009	4.30	0.130

12. Paints**Key Points**

Moisture content in paints causes bubbling, condensation and lumps in painted surfaces. Moisture measurement is, therefore, very important for quality management.

Drying methods cannot be used as there is a risk that other constituents will vaporize with the water. Distillation is also unsuitable because it takes too long, and because many paints include hydrophilic substances that are difficult to separate. As a result, Karl Fischer titration has been chosen as the moisture measurement method for paints and it is stipulated as a Japanese industrial Standard (K5407).

Paints include a variety of film-forming substances as well as various other ingredients such as enamels with pigments and varnishes, some of which may react with Karl Fischer reagent.

The possibility that some of these substances will cause an interference reaction is something that must be checked in advance.

JIS K5407 (testing method for paint constituents) stipulates both volumetric and coulometric titration. The level of moisture content in paints is generally within the range for either method. If a product contains a number of substances that will not dissolve in solvents, volumetric titration should be used in preference to coulometric titration.

For volumetric titration, the sample must be dissolved or dispersed in a suitable solvent in preparation for Karl Fischer titration. A ketone-type dehydrated solvent is excellent for samples that contain ketones. If a sample contains other substances that cause interference reactions, Karl Fischer titration should be used in combination with moisture vaporization. Either volumetric or coulometric titration can be used in such cases.

Because of the high viscosity of most paints, it is difficult to obtain a sample and inject it into a titration cell. Select equipment that matches the characteristics of the sample, such as a thick needle (2mm diameter), a sampling spoon or a glass rod.
 (now, JIS K5407 is abolished.)

[Examples of Measurement]**(1) Volumetric titration**

Reagents used: Karl Fischer Reagent SS-Z (or SS) 25-50ml
 Dehydrated Solvent OL II, KT (or CM, CP)

Substance	Dehydrated solvents	Sample Quantity(g)	Measurement Value(mg)	Moisture Content (%)
Epoxy resin paints	Oil-type	0.6645	0.43	647ppm
Fluoroethylene resin paints	"	1.0017	1.11	0.111
Paints	"	0.9953	4.97	0.499
Paint thinners (incl.MEK)	Ketone-type	4.8894	4.33	886ppm
Melamine varnish	"	0.1504	1.09	0.725

(2) Moisture vaporization - Coulometric titration

Reagents used: Aquamicon AX (or AS) 150ml
 Aquamicon CXU 10ml

Substance	Heating Temperature (°C)	Sample Quantity(g)	Measurement Value(μg)	Moisture Content (%)
Enamel	150	0.1388	1902	1.37
Paints	130	1.3175	742	563ppm
Lacquer paint	200	0.0650	2798	4.300
Powder paint	180	0.4513	1395	0.309
Epoxy resin paint	150	2.2101	1454	658ppm
Fluoroethylene resin paint	180	1.0507	1170	0.111
Polyester paint	150	0.1931	978	0.506
Liquid varnish	300	0.1122	1934	1.73
Melamine varnish	110	0.1894	1324	0.699

13. Printing Inks and Imaging Materials

Key Points

Volumetric titration is used for printing inks and imaging materials. Inks in particular may have a high moisture content. Samples can be obtained in small quantities and directly dissolved or dispersed in dehydrated solvent for Karl Fischer titration. Coulometric titration is commonly used in conjunction with moisture vaporization for samples that cannot be dissolved in solvent or that contain interference substances.

Because of the high viscosity of many inks, it may be difficult to obtain a sample and inject it into a titration cell. Select equipment that matches the characteristics of the sample, such as a thick needle (2mm diameter), a sampling spoon or a glass rod.

[Examples of Measurement]

(1) Volumetric titration

Reagents used: Karl Fischer Reagent SS-Z (or SS)

Dehydrated Solvent GEX, KTX, OL II (or MS, CP, CM) 25-50ml

Substance	Dehydrated solvents	Sample Quantity(g)	Measurement Value(mg)	Moisture Content (%)
Printing ink	General-use	0.4511	5.85	1.30
Offset ink	Oil-type	1.0834	4.33	0.400
Metallic ink	"	0.3172	1.66	0.523
Oil-based ink	"	0.1768	22.83	12.9
Water-based ink	"	0.0209	17.51	83.8
Emulsion ink	"	0.0561	31.75	56.6
Inkjet ink	"	0.0372	27.34	73.5
Gravure ink	Ketone-type	0.4125	1.38	0.335
[Printing ink pigment]				
Carmine 6B	Oil-type	0.4606	3.28	0.712
Lake red	"	0.4174	0.71	0.170
Copper phthalophenone yellow	"	0.5640	0.74	0.131
Benzidine yellow	"	0.6273	0.74	0.118
[Ink raw materials]				
Acrylates	General-use	0.6104	1.54	0.252
Epoxy resins	Oil-type	0.8443	4.80	0.569
Phenolic novolak	"	0.7655	3.87	0.506
Photosensitive resins	"	0.0315	6.90	21.9
Toners	Ketone-type	0.1374	1.02	0.742

(2) Moisture vaporization - Volumetric titration

Reagents used: Karl Fischer Reagent SS-Z (or SS)

Dehydrated Solvent GEX (or MS) + PG (3:1) 50-100ml

Substance	Heating Temperature (°C)	Sample Quantity(g)	Measurement Value(mg)	Moisture Content (%)
Emulsion inks	200	0.0626	34.78	55.7
Water-based ball-pen inks	200	0.0338	18.68	55.3

14. Adhesives

Key Points

The moisture content of adhesives ranges from minute to high, so both volumetric and coulometric titration are used. For volumetric titration, the sample is dissolved or dispersed in a suitable solvent. Moisture vaporization is used for substances that are totally insoluble.

Coulometric titration can be carried out directly in the case of substances that dissolve in electrolytes. Moisture vaporization is used for samples that are even slightly insoluble.

Adhesives are very viscous and instant adhesives solidify quickly when exposed to air. Because of these and other characteristics, a number of samples are very difficult to handle and sampling equipment must be selected with reference to the attributes of each sample. If the viscosity of the product allows it to be sampled in a syringe, use a thick needle (2mm diameter). For substances with higher viscosity, use a sampling spoon or glass rod. Special procedures are needed for instant adhesives. Refer to the following document.

Reference: Muroi, K. et al., "Determination of Minute Traces of Water in Cyanoacrylate Adhesive Compositions by the Coulometric Karl Fischer Titration Method Using the Anodic Electrolytic for Ketones" in Journal of the Japan Adhesive Society 21, 186 (1985).

[Examples of Measurement]**(1) Volumetric titration**

Reagents used: Karl Fischer Reagent SS-Z (or SS)
Dehydrated Solvent OL II, KTX (or CM, CP) 25-50m

Substance	Dehydrated solvents	Sample Quantity(g)	Measurement Value(mg)	Moisture Content (%)
Porcelain adhesives	Oil-type	1.5001	1.65	0.110
Aluminum adhesives	"	0.5508	3.75	0.681
Woodworking bonds	"	0.0785	46.70	59.5
Construction putties	"	0.2324	1.78	0.766
Rubber-metal adhesives	Ketone-type	0.6883	3.14	0.456
Adhesives	"	4.4427	0.79	178ppm

(2) Moisture vaporization - Volumetric titration

Reagents used: Karl Fischer Reagent SS-Z (or SS)
Dehydrated Solvent GEX (or MS) + PG (3:1) 50-100ml

Substance	Heating Temperature (°C)	Sample Quantity(g)	Measurement Value(mg)	Moisture Content (%)
Pastes	150	0.4960	1.59	0.321
Woodworking bonds	200	0.0546	32.24	59.1
Construction putties	250	0.8479	2.33	0.275

(3) Coulometric titration

Reagents used: Aquamicon AX (or AS), AKX 100ml
Aquamicon CXU 5ml

Substance	Electrolyte	Sample Quantity(g)	Measurement Value(µg)	Moisture Content (%)
Epoxy resins	General-use	0.5112	1507	295
Isocyanate hardeners	"	1.5368	98	64
Bonds	"	0.9403	524	557
Cyanoacrylates	ketone-type	1.9786	430	217
Adhesives	"	2.3736	430	181

(4) Moisture vaporization - Coulometric titration

Reagents used: Aquamicon AX (or AS) 150ml
Aquamicon CXU 10ml

Substance	Heating Temperature (°C)	Sample Quantity(g)	Measurement Value(µg)	Moisture Content (%)
Epoxy resins (powder)	250	0.7074	1080	0.153
Isocyanates (principal)	180	0.3079	941	0.306
Silicon bonds	210	0.4800	909	0.189
Aluminum adhesives	200	0.2670	1180	0.442
Pastes	150	0.3230	954	0.295
Porcelain adhesives	180	0.9336	964	0.103
Sealing compounds	230	0.4367	1218	0.279

15. Soaps and Detergents**Key Points**

Because soaps and detergents generally have a high moisture content, volumetric titration is used. The moisture vaporization method is used for metallic soaps, some of which cause interference. Direct coulometric titration can be used for samples that will dissolve in electrolyte.

[Examples of Measurement]**(1) Volumetric titration**

Reagents used: Karl Fischer Reagent SS-Z (or SS)
Dehydrated Solvent GEX, OL II(or MS,CM) 30-50ml

Substance	Dehydrated solvents	Sample Quantity(g)	Measurement Value(mg)	Moisture Content (%)
Cosmetic soap	Oil-type	0.0836	9.61	11.5
Soft soap	General-use	0.2133	41.59	19.5
Facial soap	"	0.0549	10.84	19.8
Cleansers	"	0.0391	21.36	54.6
Shampoo	"	0.0353	27.68	78.4
Alkyl benzene sulfonate	"	0.2551	2.29	0.897
ABS detergents	"	0.0345	26.23	76.0
Laundry detergents	"	0.0707	6.03	8.60
High-grade alcohol detergents	"	0.1366	81.41	59.9
Liquid detergent	"	0.0453	20.54	45.4
Anionic surfactants	"	0.5323	10.86	2.04
Cationic surfactants	"	3.0084	1.84	612ppm
Nonionic surfactants	"	3.0155	1.48	491ppm
Amphoteric surfactants	"	1.0295	11.43	1.11
Polyglycerine	"	1.5572	5.45	0.350

(2) Moisture vaporization - Volumetric titration

Reagents used: Karl Fischer Reagent SS-Z (or SS)

Dehydrated Solvent GEX (or MS) + PG (3:1) 50-100ml

Substance	Heating Temperature (°C)	Sample Quantity(g)	Measurement Value(mg)	Moisture Content (%)
Cosmetic soaps	200	0.0739	7.65	10.4
Facial soaps	180	0.0998	19.76	19.8
Alkyl benzene sulfonate	150	0.1870	1.69	0.904
ABS detergents	130	0.0303	22.80	76.0
Laundry detergents	180	0.0690	5.84	8.46
Cleansers	200	0.0503	27.47	54.6

(3) Coulometric titration

Reagents used: Aquamicon AX (or AS)

Aquamicon CXU

100ml

5ml

Substance	Sample Quantity(g)	Measurement Value(mg)	Moisture Content (%)
Soaps	0.2934	1314	0.448
Shampoos	0.0209	16073	76.9

(4) Moisture vaporization - Coulometric titration

Reagents used: Aquamicon AX (or AS)

150ml

Aquamicon CXU

10ml

Substance	Heating Temperature (°C)	Sample Quantity(g)	Measurement Value(µg)	Moisture Content (%)
Detergents	180	0.0324	5084	15.7
Soaps	150	0.4901	1517	0.310
Cleansers	600	0.0330	2475	7.50

16. Cosmetics**Key Points**

Creams, emulsions, rinses, hair tonics, lotions and other cosmetics have high moisture content. Accordingly, volumetric titration is the main method used with these items. When carrying out the volumetric titration it is convenient to use a high-titer Karl Fischer reagent. An oil-type dehydrated solvent is used for products with a high oil content, such as creams. A general-purpose dehydrated solvent is used for hair tonics and lotions.

Coulometric titration can also be used. However, the high moisture content of these products means that titration will be prolonged, even with small samples. For this reason, volumetric titration should be used whenever possible.

Sampling devices should be selected carefully. Viscous products such as creams should be sampled with a sampling spoon and dissolved directly in the dehydrated solvent. For lotions and similar products, a sampling flask with pipette is convenient. For cosmetics that will not dissolve in dehydrated solvent, volumetric or coulometric titration should be used in combination with moisture vaporization.

[Examples of Measurement]**(1) Volumetric titration**

Reagents used: Karl Fischer Reagent SS-Z (or SS)

Dehydrated Solvent GEX, OL II (or MS, CM) 25-50ml

Substance	Dehydrated solvents	Sample Quantity(g)	Measurement Value(mg)	Moisture Content (%)
Cream	Oil-type	0.1072	61.21	57.1
Emulsion	"	0.1011	74.61	73.8
Rinse	"	0.1151	88.39	76.8
Nourishing cream	"	0.0281	12.72	45.3
Cleansing cream	"	0.0454	15.00	33.0
Cold cream	"	0.0556	14.09	25.3
Hair tonic	General-use	0.0409	17.33	42.4
Hair treatments	"	0.0328	16.92	51.6

(2) Moisture vaporization - Volumetric titration

Reagents used: Karl Fischer Reagent SS-Z (or SS)

Dehydrated Solvent GEX (or MS) + PG (3:1) 50-100ml

Substance	Heating Temperature (°C)	Sample Quantity(g)	Measurement Value(mg)	Moisture Content (%)
Mascara	150	0.0262	13.53	51.6
Essence	150	0.0660	43.42	65.8

(3) Coulometric titration

Reagents used: Aquamicon AX (or AS)

100ml

Aquamicon CXU

5ml

Substance	Sample Quantity(g)	Measurement Value(µg)	Moisture Content (%)
Cream	0.0364	23089	63.4
Cleansing cream	0.0416	11188	26.9
Emulsion	0.0330	28611	86.7
Cream lotion	0.0153	11580	75.7

(4) Moisture vaporization - Coulometric titration

Reagents used: Aquamicon AX (or AS)

150ml

Aquamicon CXU

10ml

Substance	Heating Temperature (°C)	Sample Quantity(g)	Measurement Value(µg)	Moisture Content (%)
Lip cream	180	0.0722	4871	6.75
Cream lotion	180	0.0180	13600	75.6

17. Chemicals & Materials for Electronic Equipment and Electrical Parts**Key Points**

Materials for electronic equipment and electrical parts are made of mixed or composite materials. They vary widely in terms of both the raw materials and their form. The methods used to measure moisture content must be selected with reference to the characteristics of each item. These items generally have a low moisture content and many are insoluble in solvents. For this reason, moisture content is measured using moisture vaporization and coulometric titration.

Chemical products such as liquid crystals, photoresists and capacitor electrolytes can be dissolved in dehydrated solvents or electrolytes.

This means that they can be titrated directly using volumetric or coulometric titration.

Chemical substances may be either liquid or solid. For viscous liquids, a syringe with a 2mm diameter needle should be used.

[Examples of Measurement]**(1) Volumetric titration**

Reagents used: Karl Fischer Reagent SS-Z (or SS)

Dehydrated Solvent GEX, OL II (or MS, CM) 25-50ml

Substance	Dehydrated solvents	Sample Quantity(g)	Measurement Value(mg)	Moisture Content (%)
Capacitor electrolyte	General-use	0.0454	3.67	8.08
Liquid crystal	"	1.0998	0.23	209ppm
Photoresist	Oil-type	1.0823	3.23	0.298

(2) Coulometric titration

Reagents used: Aquamicon AX (or AS)

100ml

Aquamicon CXU

5ml

Substance	Sample Quantity(g)	Measurement Value(µg)	Moisture Content (%)
Liquid crystal	1.0504	196	187ppm
Photoresist	0.5578	998	0.179

(3) Moisture vaporization - Coulometric titration

Reagents used: Aquamicon AX (or AS)

150ml

Aquamicon CXU

10ml

Substance	Heating Temperature (°C)	Sample Quantity(g)	Measurement Value(µg)	Moisture Content (%)
Liquid crystal	180	2.2303	248	111ppm
Photoresist	180	1.7653	334	189ppm
Capacitor	260	0.1194	217	0.182
IC chip	250	0.6872	1709	0.249
Silicon wafer	700	4.1167	29	7ppm
Printed circuit board	200	0.0976	1303	1.340
Polycarbonate disk	230	0.4430	678	0.153

III-2. Foodstuffs

The food category encompasses a wide range of substances with varying properties.

It includes agricultural, livestock and marine products and processed products, as well as food additives. The moisture content of these items also varies widely. It is necessary, therefore, to select the most appropriate sample handling procedures and measurement method for each individual product.

Test methods for foodstuffs are mostly stipulated in the JAS standards. In most cases moisture content is measured using heating and drying methods, but Karl Fischer titration is specified for some items. In the case of chemically defined foodstuffs, such as sugars and additives, Karl Fischer titration can be applied using the same methods as for normal chemicals.

Food items with complex structures, such as cereals and meats, contain not only adhesion moisture but also moisture incorporated within cells.

Measurement results for these items are provided for your information.

Because many food items do not dissolve in organic solvents, the moisture vaporization method is used extensively. However, foodstuffs commonly become unstable when heated, and water may be formed as substances break down. Care must be taken, therefore, when setting analytical conditions.

1. Food Additives and Flavorings**Key Points**

Food additives are substances used in the manufacture, processing and preservation of foodstuffs. There are many types with varying attributes. Most are solid, but those that dissolve in dehydrated solvents or electrolytes can be titrated directly using Karl Fischer titration.

However, it is necessary first to determine whether or not interference substances are present. Direct titration should be avoided in the case of insoluble substances, and the moisture vaporization method is recommended. As the moisture content of these substances is generally high, volumetric titration is used.

However, coulometric titration can also be used if the sample quantity is kept small.

When using moisture vaporization, it is necessary to set the measurement conditions after determination of the heating temperature.

Official specifications for food additives commonly stipulate the loss-on-drying method, so conformance with that method should be checked.

[Examples of Measurement]

(1) Volumetric titration

Reagents used: Karl Fischer Reagent SS-Z (or SS)
Dehydrated Solvent GEX, SU (or MS, FM) 25-50ml

Substance	Dehydrated solvents	Sample Quantity(g)	Measurement Value(mg)	Moisture Content (%)
[Flavorings]				
Flavor	General-use	0.0228	10.93	48.0
Orange powder	"	0.2623	5.01	1.91
Palm lemon	Sugar-type	0.0765	7.08	9.25
Strawberry powder	"	0.2789	3.69	1.33
[Condiments]				
Sodium citrate	General-use	0.1711	20.97	12.3
Sodium 5'-inosinate	Sugar-type	0.0802	20.65	25.7
Sodium glutamate	"	0.1303	13.38	10.3
Yeast extract	"	0.0810	2.84	3.65
[Emulsifiers]				
Sorbitan fatty acid ester	General-use	2.0962	2.95	0.141
[Sweeteners]				
Potassium glycylic rhizinate	General-use	0.1652	12.45	7.54
Maltitol	Sugar-type	0.1891	25.77	13.6
Sorbit	"	0.4317	2.71	0.628
Aspartame	"	0.0535	1.33	2.49
[Preservatives]				
Sorbic acid	General-use	1.0059	1.14	0.113
Potassium sorbate	"	1.0489	0.53	505ppm
Sodium benzoate	"	1.0787	6.89	0.639
[Strengtheners]				
Thiamine hydrochloride	General-use	0.2321	9.89	4.26
Calcium lactate	Sugar-type	0.0475	13.75	28.9
[Acidulants]				
Malic acid	General-use	1.0382	2.52	0.243
Citric acid	"	0.1044	9.23	8.84
[Water-retaining emulsifying stabilizer]				
Sodium chondroitin sulfate	Sugar-type	0.0483	4.49	9.30

(2) Moisture vaporization - Volumetric titration

Reagents used: Aquamicon SS-Z (or SS) 150ml
Dehydrated Solvent GEX (or MS) + PG (3:1) 50-100ml

Substance	Heating Temperature (°C)	Sample Quantity(g)	Measurement Value(mg)	Moisture Content (%)
[Flavorings]				
Cheese powder	130	0.1915	12.34	6.44
Vanilla powder	130	0.1161	4.70	4.05
Yoghurt powder	130	0.0984	8.47	8.61
Strawberry powder	150	0.3188	4.25	1.33
Orange powder	150	0.2943	6.01	2.04
Palm lemon	180	0.0630	5.68	9.02
[Strengtheners]				
Calcium lactate	200	0.0513	14.50	28.3

(3) Coulometric titration

Reagents used: Aquamicon AX (or AS) 100ml
Aquamicon CXU 5ml

Substance	Sample Quantity(g)	Measurement Value(µg)	Moisture Content (%)
Sodium 5'-inosinate	0.0524	13467	25.7
Sodium citrate	0.0785	9649	12.3
Sorbic acid	0.9221	1048	0.114
Potassium sorbate	1.0728	411	383ppm
Sodium benzoate	1.0179	6463	0.635
Malic acid	1.0728	2471	0.230
Saccharin	0.0921	12813	13.9

(4) Moisture vaporization - Coulometric titration

Reagents used: Aquamicon AX (or AS)

150ml

Aquamicon CXU

10ml

Substance	Heating Temperature (°C)	Sample Quantity(g)	Measurement Value(µg)	Moisture Content (%)
[Condiments]				
Sodium glutamate	080	1.1071	358	323ppm
Sodium glutamate	180	0.0484	4739	9.79
Disodium succinate	120	0.0536	21575	40.3
Trisodium citrate	200	0.1071	13056	12.2
Yeast extract	080	0.0391	1446	3.70
Sodium 5'-guanylate	200	0.0249	4744	19.1
Sodium 5'-inosinate	200	0.0165	4256	25.8
[Sweeteners]				
Saccharin	150	0.0648	8869	13.7
Aspartame	150	0.0426	1001	2.35
[Preservatives]				
Sorbic acid	160	1.0252	3495	0.341
Potassium sorbate	160	1.0139	341	336ppm
Sodium benzoate	160	1.0259	6456	0.629
[Strengtheners]				
Calcium citrate	150	0.0940	12257	13.0
[Acidulants]				
Malic acid	105	1.0389	2132	0.205
[Quality enhancers]				
Sodium polyphosphate	130	2.0194	4988	0.247
[Water-retaining emulsifying stabilizer]				
Sodium chondroitin sulfate	150	0.0440	4182	9.5

2. Cereals and Dried Vegetables**Key Points**

Volumetric titration is suitable for cereals and starches which have a high moisture content (approximately 10%). If the sample is in powder form it can be dispersed in dehydrated solvent, allowing the moisture content to be extracted for direct Karl Fischer titration. When using a dehydrated solvent with sugars, solubility is sometimes enhanced if the temperature is raised to 40-45°C before titration. The moisture vaporization method is suitable for the many items that do not dissolve in solvents. Care needs to be taken with the heating temperature for moisture vaporization. Temperatures in the 130-180°C range are commonly used. High temperatures may cause various phenomena, including discoloration, abnormal results or failure to reach an end point. In such cases the measurement must be repeated at a lower temperature.

Moisture vaporization should be used with coulometric titration. Cereals cannot be titrated directly as they do not dissolve in electrolytes.

Cereals are sometimes sampled after preliminary processing (e.g. pulverization).

Care is needed to avoid moisture vaporization or absorption during these processes.

Volumetric titration is the principal method used for dried vegetables.

The sample is added to the dehydrated solvent and stirred well for a period of 5-10 minutes before direct titration. Moisture vaporization is used when the moisture content cannot be fully extracted from samples in this way. Karl Fischer titration can be carried out using either the volumetric or coulometric methods. As moisture content tends to be high, however, volumetric titration is usually preferable.

The precautions stipulated for moisture vaporization in connection with cereals also apply to dried vegetables.

[Examples of Measurement]**(1) Volumetric titration**

Reagents used: Karl Fischer Reagent SS-Z (or SS)

Dehydrated Solvent GEX, SU (or MS, FM) 25-50ml

Substance	Dehydrated solvents	Sample Quantity(g)	Measurement Value(mg)	Moisture Content (%)
Apple powder	General-use	0.0989	2.16	2.19
Dried carrot powder	"	0.1231	3.74	3.04
Dried onions	"	0.0366	2.81	7.68
Dried tomato powder	"	0.1309	3.07	2.35
Sweet potato starch	"	0.1885	31.10	16.5
Corn flour	"	0.0627	6.06	9.67
Soy protein	"	0.0574	4.09	7.13
Corn starch	Sugar-type	0.1612	21.15	13.1
Wheat	"	0.0635	9.05	14.3
Soy protein	"	0.0756	5.43	7.18
Soy flour	"	0.0692	5.26	7.60
Potato powder	Sugar-type (45°C)	0.0721	5.80	8.04

(2) Moisture vaporization - Volumetric titration

Reagents used: Karl Fischer Reagent SS-Z (or SS)

Dehydrated Solvent GEX (or MS) + PG (3:1) 50-100ml

Substance	Heating Temperature (°C)	Sample Quantity(g)	Measurement Value(mg)	Moisture Content (%)
Corn starch	150	0.1103	13.77	12.5
Maize	130	0.0529	6.34	12.0
Wheat flour	180	0.0826	13.10	15.9
Corn flour	180	0.1421	53.65	37.8
Devil's-tongue flour	130	0.1270	11.30	8.90
Apple powder	110	0.1647	3.60	2.19
Dried onions	70	0.0457	3.44	7.53
Soy flour	150	0.0719	5.33	7.41

(3) Moisture vaporization - Coulometric titration

Reagents used: Aquamicon AX (or AS)

150ml

Aquamicon CXU

10ml

Substance	Heating Temperature (°C)	Sample Quantity(g)	Measurement Value(μg)	Moisture Content (%)
Corn starch	150	0.0490	6409	13.1
Wheat	150	0.0524	7498	14.3
Malt	110	0.0764	4530	5.93
Maize	150	0.0482	7009	14.5
Wheat flour	130	0.0659	6382	9.68
Soy protein	150	0.0463	3337	7.21
Potato powder	110	0.0602	4876	8.10

3. Sugars and Condiments**Key Points**

Sugars are dissolved in a sugar-type dehydrated solvent and titrated. Volumetric titration is used. If a substance is slow or difficult to dissolve the solvent can be heated (up to 50°C) and titrated. (If the temperature exceeds 50°C the formamide in the sugar-type dehydrated solvent will gradually break down. The Karl Fischer reagent will be consumed in small amounts leading to uncertainty about the end point.)

Condiments are normally dispersed in general-use dehydrated solvent. This is followed by extraction and titration. If the ingredients of a particular item give it a high sugar content, a sugar-type dehydrated solvent is used. An oil-type dehydrated solvent is used for products with a high fat content. Moisture vaporization should generally be avoided for sugars as they tend to break down when heated. Moisture vaporization is unnecessary for condiments, since in almost all cases moisture content can be measured using direct titration. When using the moisture vaporization method the optimal heating temperature must be determined first. Changes in the sample could lead to errors.

[Examples of Measurement]**(1) Volumetric titration**

Reagents used: Karl Fischer Reagent SS-Z (or SS)

Dehydrated Solvent GEX, SU, OL II (or MS, FM) 25-50ml

Substance	Dehydrated solvents	Sample Quantity(g)	Measurement Value(mg)	Moisture Content (%)
Wasabi paste	General-use	0.0465	10.23	22.0
Roast meat gravy	"	0.0187	10.66	57.0
Soy sauce	"	0.0265	17.55	66.2
Soup powder	"	0.0754	2.89	3.83
Bonito stock	"	0.1475	7.48	5.07
Sugar syrup	"	0.0691	40.56	58.7
Powdered miso	"	0.1228	3.79	3.09
Glucose	Sugar-type	1.1052	1.64	0.148
White sugar	"	0.2550	3.51	1.38
Maltose	"	0.0695	3.56	5.12
Malt syrup	"	0.0505	12.49	24.9
Soup	"	0.0322	19.87	61.7
Refined sugar	Sugar-type(40°C)	0.4729	4.04	0.854
Soup stock	Sugar-type(40°C)	0.4363	5.66	4.22
Granulated sugar	Sugar-type(45°C)	2.8133	0.71	252ppm
Mayonnaise	Oil-type	0.1425	28.93	20.3

(2) Moisture vaporization - Volumetric titration

Reagents used: Karl Fischer Reagent SS-Z (or SS)
Dehydrated Solvent GEX (or MS) + PG (3:1) 50-100ml

Substance	Heating Temperature (°C)	Sample Quantity(g)	Measurement Value(mg)	Moisture Content (%)
Soup powder	90	0.0824	3.70	4.49
Wasabi paste	110	0.0522	11.68	22.4
Soy sauce	200	0.0399	24.07	60.3
Mayonnaise	200	0.1408	28.61	20.3

(3) Moisture vaporization - Coulometric titration

Reagents used: Aquamicon AX (or AS) 150ml
Aquamicon CXU 10ml

Substance	Heating Temperature (°C)	Sample Quantity(g)	Measurement Value(µg)	Moisture Content (%)
Sugar	130	0.4853	3669	1.98
Spices	130	0.0412	5830	14.2

4. Confectionery**Key Points**

Because sugar is the main ingredient of confectionery, these items are dissolved in a sugar-type dehydrated solvent for titration. Volumetric titration is used.

Coulometric titration is normally avoided as these products will not dissolve in electrolytes. The moisture vaporization method is also in some cases unsuitable as heating causes sugars to break down and produce water.

Caramels, candies and similar items are titrated after they have been dissolved in a sugar-type dehydrated solvent that has been heated (up to 45°C). (If the temperature exceeds 45°C the formamide in the sugartype dehydrated solvent will gradually break down. The Karl Fischer reagent will be consumed in small amounts and this will lead to uncertainty about the end point.) The moisture vaporization method can be used for snack-type confectionery.

[Examples of Measurement]**(1) Volumetric titration**

Reagents used: Karl Fischer Reagent SS-Z (or SS)
Dehydrated Solvent SU (or FM) at 40°C 25-50ml

Substance	Sample Quantity(g)	Measurement Value(mg)	Moisture Content (%)
Malt syrup	0.0505	12.59	24.9
Candy	0.1893	5.78	3.05
Drops	0.2674	5.77	2.16
Milk caramel	0.2869	23.42	8.16
Cream caramel	0.1206	9.93	8.24
Chocolate	0.3153	3.18	1.01
Wafers	0.5500	12.76	2.32
Chocolate cream	0.0999	12.13	12.1
Chocolate emulsifier	0.2527	5.83	2.31
Chewing gum	0.2978	5.63	1.89
Corn snack	0.2217	3.24	1.46

(2) Moisture vaporization - Volumetric titration

Reagents used: Karl Fischer Reagent SS-Z (or SS)
Dehydrated Solvent GEX (or MS) + PG (3:1) 50-100ml

Substance	Heating Temperature (°C)	Sample Quantity(g)	Measurement Value(µg)	Moisture Content (%)
Potato chips	130	0.1814	3.73	2.06
Biscuits	130	0.3821	12.72	3.33
Corn snacks	130	0.2462	3.44	1.40

(3) Moisture vaporization - Coulometric titration

Reagents used: Aquamicon AX (or AS) 150ml
Aquamicon CXU 10ml

Substance	Heating Temperature (°C)	Sample Quantity(g)	Measurement Value(µg)	Moisture Content (%)
Small rice crackers	130	0.0377	2776	7.36

5. Dairy Products, Fat Products

Key Points

Because of their high moisture content, most dairy products are titrated directly using the volumetric method. A sugar-type dehydrated solvent is normally used as the titration solvent. However, products that have fats as their principal ingredients, such as butter, are dissolved in an oil-type dehydrated solvent for titration. When volumetric titration is used for fat products they are dissolved in an oil-type dehydrated solvent.

The moisture content of vegetable oils, which contain little water, can be measured more accurately using coulometric titration.

If a product will not dissolve readily in the electrolyte, the addition of chloroform to the anolyte (equivalent to 20% by volume of anolyte) will allow the substance to dissolve for repeat titrations.

The moisture vaporization method can be used for samples of these types. However, the conditions must be determined with care. As a general rule, a heating temperature in the 110-180°C range is used.

[Examples of Measurement]

(1) Volumetric titration

Reagents used: Karl Fischer Reagent SS-Z (or SS)

Dehydrated Solvent GEX, OL II, SU (or MS, CM, FM) 25-50ml

Substance	Dehydrated solvents	Sample Quantity(g)	Measurement Value(mg)	Moisture Content (%)
Powdered milk	General-use	0.0572	2.64	4.56
Cream cheese	"	0.0485	25.04	51.6
Natural cheese	"	0.1143	72.16	63.1
Milk powder	Sugar-type	1.0888	30.55	2.81
Condensed milk	"	0.0730	19.42	26.6
Fresh cream	"	0.1142	16.74	14.7
Powdered cheese	"	0.1269	5.43	4.28
Meat extract	"	0.1067	18.59	17.4
Rapeseed oil	Oil-type	4.6163	0.51	110ppm
Butter	"	0.0303	4.25	14.0
Margarine	"	0.0970	15.49	16.0

Sugar-type dehydrated solvent should be heated to 40°C before use in titration.

(2) Moisture vaporization - Volumetric titration

Reagents used: Karl Fischer Reagent SS-Z (or SS)

Dehydrated Solvent GEX (or MS) + PG (3:1) 50-100ml

Substance	Heating Temperature (°C)	Sample Quantity(g)	Measurement Value(mg)	Moisture Content (%)
Cream cheese	130	0.1147	59.14	51.6
Natural cheese	130	0.0898	57.00	63.5
Meat extract	180	0.0705	12.17	17.3
Margarine	150	0.1281	19.97	15.6

(3) Coulometric titration

Reagents used: Aquamicon AX (or AS)

Aquamicon CXU 100ml
5ml

Substance	Sample Quantity(g)	Measurement Value(µg)	Moisture Content (%)
Powdered milk	0.2071	5852	2.83
Butter	0.0422	5845	13.9
Cheese	0.0142	5840	41.1
Palm oil	0.3189	303	950ppm
Sesame oil	0.9017	534	592ppm
Soy bean oil	4.5118	229	51ppm
Salad oil	2.7354	394	144ppm

(4) Moisture vaporization - Coulometric titration

Reagents used: Aquamicon AX (or AS)

Aquamicon CXU 150ml
10ml

Substance	Heating Temperature (°C)	Sample Quantity(g)	Measurement Value(µg)	Moisture Content (%)
Powdered milk	110	0.0648	2953	4.56
Cheese	130	0.0217	8982	41.4

6. Gourmet Foods, etc.

Key Points

Volumetric titration is normally used for gourmet foods because of their high moisture content. They are dissolved in a sugar-type dehydrated solvent and subjected to Karl Fischer titration. If a product will not dissolve readily the solvent can be heated to 40°C. An oil-type dehydrated solvent is used for high-fat foods. A general-purpose dehydrated solvent may be used for some samples. If the moisture content cannot be extracted fully using these solvents, Karl Fischer titration is used in conjunction with moisture vaporization. Either volumetric or coulometric titration can be used in such cases. In the case of coulometric titration, direct titration should be avoided because of problems with the solubility of samples.

[Examples of Measurement]

(1) Volumetric titration

Reagents used: Karl Fischer Reagent SS-Z (or SS)
Dehydrated Solvent GEX, SU, OL II (or MS, FM, CM) 25-50ml

Substance	Dehydrated solvents	Sample Quantity(g)	Measurement Value(mg)	Moisture Content (%)
Powdered egg yolk	General-use	0.0610	2.96	4.85
Dried beer yeast	"	0.0820	3.02	3.68
Coffee	Sugar-type	0.1287	3.87	3.01
Cocoa	"	0.3632	5.60	1.54
Juice powder	"	0.4695	4.07	0.867
Raw coffee beans	Sugar-type (40°C)	0.0574	5.45	9.49
Tea	Sugar-type (40°C)	1.0516	5.80	0.552
Gelatine	Sugar-type (40°C)	0.0170	2.59	15.2
Soy milk	Oil-type	0.0663	57.26	86.4
Curry roux	"	01353	4.57	3.38

(2) Moisture vaporization - Volumetric titration

Reagents used: Karl Fischer Reagent SS-Z (or SS)
Dehydrated Solvent GEX (or MS) + PG (3:1) 50-100ml

Substance	Heating Temperature (°C)	Sample Quantity(g)	Measurement Value(mg)	Moisture Content (%)
Coffee beans	130	0.1919	4.11	2.14
Dried beer yeast	200	0.0840	8.86	10.6
Curry roux	130	0.1217	4.31	3.54

(3) Moisture vaporization - Coulometric titration

Reagents used: Aquamicon AX (or AS) 150ml
Aquamicon CXU 10ml

Substance	Heating Temperature (°C)	Sample Quantity(g)	Measurement Value(µg)	Moisture Content (%)
Coffee	90	0.1282	3229	2.52
Raw coffee beans	150	0.0555	5012	9.03
Cocoa	110	0.2486	3973	1.60
Hops	130	0.0189	1536	8.14
Beet	130	0.0913	7669	8.40
Gelatine	180	0.0114	1790	15.7

III-3. Pharmaceuticals

In this field, Karl Fischer titration is the most effective tool for precise moisture content measurement. Moisture content tends to be high, ranging from a few percent up to a few tens of percent. For this reason, volumetric titration is generally used.

The examples in this section show the application of Karl Fischer titration to biochemical and pharmaceutical products. Where the chemical ingredients of these products are known direct titration can be used as it is possible to determine whether or not interference will occur.

Even if products cause interference, they can still be measured using moisture vaporization and Karl Fischer titration, provided that they remain stable when exposed to heat.

Special pharmaceutical items are listed in the Japanese Pharmacopoeia.

Aside from volumetric titration, the coulometric titration and moisture vaporization methods can also be used. This chapter gives examples based on the actual implementation of these methods.

1. Biochemical Products

Key Points

Sugar-type dehydrated solvents are generally used when applying volumetric titration to biochemical products such as amino acids, nucleic acids, sugars, enzymes and lipids. Even substances that do not dissolve in general-use dehydrated solvents can be titrated directly using a general-use dehydrated solvent, provided that the moisture content of the sample can be extracted adequately.

Direct coulometric titration is not suitable as many samples cannot be dissolved in the anolytes used for this type of titration. Coulometric titration is carried out using the moisture vaporization method. Some samples break down at certain heating temperatures and there must be careful consideration of the temperature used for moisture vaporization.

L-cystine and vitamin C react with Karl Fischer reagent and cannot be titrated directly. Care is needed with general vitamin preparations that include vitamin C since these can also cause interference reactions.

(Vitamin C reacts quantitatively with iodine. If the amount of vitamin C included in a sample is known, then the moisture content can be determined by adjusting the results. Refer to the Basic Knowledge section for more information.) Moisture vaporization is used with these substances.

[Examples of Measurement]

(1) Volumetric titration

Reagents used: Karl Fischer Reagent SS-Z (or SS)

Dehydrated Solvent GEX, SU (or MS, FM) 25-50ml

Substance	Dehydrated solvents	Sample Quantity(g)	Measurement Value(mg)	Moisture Content (%)
L-alanine	General-use	0.5316	0.13	245ppm
Potassium asparaginate	"	0.1026	5.29	5.16
Glycylglycine	"	0.2882	0.24	833ppm
Vitamin B12	"	0.1452	11.27	7.76
Vitamin B1 hydrochloride	"	0.2321	9.89	4.26
ATP	"	0.0750	6.55	8.73
Citidine (5') diphosphocholine sodium	Sugar-type	0.0466	1.92	4.12
Dextran	"	0.0901	5.93	6.58
Chlorella	"	0.0550	3.54	6.44
Yeast extract	"	0.0810	0.95	3.58
Cyclodextrin	"	0.0386	1.55	4.02

(2) Moisture vaporization - Volumetric titration

Reagents used: Karl Fischer Reagent SS-Z (or SS)

Dehydrated Solvent GEX (or MS) + PG (3:1) 50-100ml

Substance	Heating Temperature (°C)	Sample Quantity(g)	Measurement Value(mg)	Moisture Content (%)
Adenosine triphosphate	200	0.0430	3.28	8.41

(3) Moisture vaporization - Coulometric titration

Reagents used: Aquamicron AX (or AS)

Aquamicron CXU 150ml
10ml

Substance	Heating Temperature (°C)	Sample Quantity(g)	Measurement Value(μg)	Moisture Content (%)
Moisture Content	150	0.7408	56	76ppm
Sodium asparaginate	180	0.0366	2020	5.52
Glycylglycine	130	0.2765	70	253ppm
L-cystine	130	0.1123	796	0.709
Dextran	180	0.0457	3093	6.76
Vitamin preparations	110	0.1211	2235	1.85
Vitamin C	100	0.1264	1275	1.01
Vitamin B12	130	0.0403	3128	7.76
Chlorella	150	0.0659	4180	6.34
Yeast extract	80	0.0391	1446	3.70
Yeast nucleic acid	200	0.0230	5875	25.5

2. Pharmaceuticals

Key Points

The Japanese Pharmacopoeia designates Karl Fischer methodology as the general testing method for various pharmaceutical products. In addition to volumetric titration, the coulometric titration and moisture-vaporization methods have also been specified. Normally, samples are placed in a general-use dehydrated solvent and stirred for a period before titration. Alternatively, surplus Karl Fischer reagent may be added to the solution, which is then stirred for a period and reverse titrated with standard water-methanol. Depending on the solubility of the sample, a sugar-type or oil-type dehydrated solvent should be used.

The chemical constituents of pharmaceutical products are usually known so it is possible to determine in advance whether or not a particular product is suitable for Karl Fischer titration. Coulometric titration is convenient when only a limited amount of sample can be obtained (such as when a substance is too valuable to use more than a few milligrams), or when moisture content is low. The moisture vaporization method is used when it is difficult to draw the moisture into the dehydrated solvent, or when interference would occur.

As with other types of substances, the heating temperature must be selected with care.

Moisture vaporization should be used only after careful consideration.

[Examples of Measurement]

(1) Volumetric titration

Reagents used: Karl Fischer Reagent SS-Z (or SS)
Dehydrated Solvent SU(or MS, FM) 25-50ml

Substance	Dehydrated solvents	Sample Quantity(g)	Measurement Value(mg)	Moisture Content (%)
Aminophylline	General-use	0.2115	8.90	4.21
Digitalis	"	0.3502	5.46	1.56
Antibiotics	"	0.1245	8.35	6.71
Gibberellin methyl ester	"	0.2005	3.31	1.65
Berberine chloride	"	0.0443	4.23	9.55
Glutathione	"	0.2713	11.51	4.24
Aspirin aluminum	"	0.1638	2.33	1.42
Carbetapeten citrate	"	0.3053	0.13	0.043
Chlorobutanol	"	0.0896	4.35	4.85
Patenol	"	0.1243	0.13	0.10
Erythromycin lactobionate	"	0.0431	1.43	10.3
Rutin	"	0.1202	11.36	9.45
Libotite	Sugar-type	0.1337	31.18	23.3
Hemin	"	0.1838	1.47	0.800
Phosphomycin Ca	"	0.1533	14.65	9.49
Pantechinan	"	0.1375	28.30	20.6
Sodium aspartate	Sugar-type (40°C)	0.0543	5.77	10.6
Throat drops	" (40°C)	0.2970	10.79	3.63

(2) Moisture vaporization - Volumetric titration

Reagents used: Karl Fischer Reagent SS-Z (or SS)
Dehydrated Solvent GEX (or MS) + PG (3:1) 50-100ml

Substance	Heating Temperature (°C)	Sample Quantity(g)	Measurement Value(mg)	Moisture Content (%)
Phosphomycin Ca	250	0.1142	10.58	9.26
Potassium xanthogenate	150	0.5009	2.42	0.483

(3) Coulometric titration

Reagents used: Aquamicon AX (or AS) 100ml
Aquamicon CXU 5ml

Substance	Sample Quantity(g)	Measurement Value(μg)	Moisture Content (%)
Albumin	0.2236	693	0.310
Polypeptide	0.0037	316	8.54
Aminophylline	0.0427	1795	4.20

(4) Moisture vaporization - Coulometric titration

Reagents used: Aquamicon AX (or AS) 150ml

Aquamicon CXU 10ml

Substance	Heating Temperature (°C)	Sample Quantity(g)	Measurement Value(µg)	Moisture Content (%)
Albumin	110	0.1818	578	0.318
Glutathione	110	0.4208	1635	0.389
Berberine chloride	150	0.0288	2735	9.56
Bufferin	130	0.0662	2645	4.00
Aspirin aluminum	150	0.1715	2332	1.36
Synthetic penicillin	150	0.0837	2616	3.13

3. Chinese Herbal Medicines, Biological Tissue, etc.**Key Points**

Either a general-use or a sugar-type dehydrated solvent is used for chinese herbal medicines. In general, however, these products are difficult to dissolve. This means that insufficient moisture is extracted and accurate analytical results cannot be obtained. The moisture vaporization method is used for this reason. The heating temperature must be considered carefully as heating can cause some products to change color or break down.

In the examples shown, biological tissue was dispersed in a general-use dehydrated solvent and subjected to Karl Fischer titration. Similar procedures should be used for capsules and other items.

[Examples of Measurement]**(1) Volumetric titration**

Reagents used: Karl Fischer Reagent SS-Z (or SS)

Dehydrated Solvent GEX, SU (or MS, FM) 25-50ml

Substance	Dehydrated solvents	Sample Quantity(g)	Measurement Value(mg)	Moisture Content (%)
Pills (heart tonic)	General-use	0.1356	8.86	6.53
Muscle	"	0.1018	75.74	74.4
Brain	"	0.0994	77.23	77.7
Blood serum	"	0.0916	83.90	91.6
Pancreas	"	0.6645	33.36	5.02
Bile acid	"	0.9185	15.15	1.65
Licorice powder	"	0.1111	9.91	8.92
Crude drugs	Sugar-type	0.0608	18.80	30.9
Capsules	" (40°C)	0.0697	9.81	14.1
Soft capsules	" (40°C)	0.0528	5.094	9.64

(2) Moisture vaporization - Volumetric titration

Reagents used: Karl Fischer Reagent SS-Z (or SS)

Dehydrated Solvent GEX (or MS) + PG (3:1) 50-100ml

Substance	Heating Temperature (°C)	Sample Quantity(g)	Measurement Value(mg)	Moisture Content (%)
Pills (heart tonic)	110	0.2215	14.51	6.55
Crude drugs	130	0.0532	16.46	30.9
Medicinal wafers	150	0.0776	12.82	16.5
Capsules	170	0.0726	10.14	14.0
Toothpaste	200	0.2069	64.33	31.1
Black hair	200	0.0726	8.09	11.1
Blond hair	200	0.1583	18.38	11.6

(3) Moisture vaporization - Coulometric titration

Reagents used: Aquamicon AX (or AS)

Aquamicon CXU

150ml

10ml

Substance	Heating Temperature (°C)	Sample Quantity(g)	Measurement Value(µg)	Moisture Content (%)
Crude drugs	130	0.0961	1254	1.30
Licorice powder	130	0.0439	3977	9.06
Cinnamon	130	0.0620	3464	5.59
Mint	110	0.0428	2411	5.63
Soft capsules	150	0.0463	4463	9.64
Gelatine capsules	150	0.0201	3262	16.2

III-4. Minerals and Natural Products

This chapter provides examples of the use of Karl Fischer titration to measure the moisture content of mineral substances such as rock, sand and iron ore. As these substances are not soluble in solvents the moisture vaporization method is, of course, used in most cases. Particular care must be taken with reference to the heating temperature as water of composition can cause problems.

Natural products vary widely and it is possible to present only a few examples here.

Refer to these when determining the analytical conditions.

1. Minerals

Key Points

With the traditional drying methodology, substances like ores and rock tended to oxidize. Measurement had to take place over long periods of time and the results were frequently inaccurate. By combining moisture vaporization with Karl Fischer titration moisture content can be measured quickly and accurately.

Karl Fischer titration can be carried out using either volumetric or coulometric methods. Volumetric titration is generally used for substances with a high moisture content. Since minerals commonly occur in lumps or granular form, samples must first be crushed into suitably fine grains. During this process care is needed to prevent moisture vaporization into, or absorption from the atmosphere.

With minerals, problems can arise not only with water of adhesion but also with water of composition (water of crystallization). Fractional measurement is achieved using the moisture vaporization method. The heating temperature is set between 100 and around 200°C for water of adhesion, and between 500 and 1,000°C when measuring water of composition. Thus, the temperature for moisture vaporization is set according to both the type of sample and the purpose of the measurement.

A commercially available dual-system heating oven provides a convenient way of obtaining accurate fractional measurements of water of adhesion and water of composition.

Reference: JIS M8211 "Iron Ores--Method for Determination of Combined Water Content"

[Examples of Measurement]

(1) Volumetric titration

Reagents used: Karl Fischer Reagent SS-Z (or SS)

Dehydrated Solvent GEX (or MS) 25-50ml

Substance	Dehydrated solvents	Sample Quantity(g)	Measurement Value(mg)	Moisture Content (%)
Soil	General-use	0.0508	23.63	46.5
Dried soil	"	0.0858	4.21	4.91
Powdered quartz	"	1.6711	0.94	0.056

(2) Moisture vaporization - Volumetric titration

Reagents used: Karl Fischer Reagent SS-Z (or SS)

Dehydrated Solvent GEX (or MS) + PG (3:1) 50-100ml

Substance	Heating Temperature (°C)	Sample Quantity(g)	Measurement Value(mg)	Moisture Content (%)
Rocks	900	0.0798	13.11	16.4
Clay	110	0.8837	34.46	3.90
"	700	0.1033	14.99	14.5
Soil	200	0.0483	22.88	47.2
Iron ore	750	0.5638	13.58	2.41
Limestone	700	0.2462	0.84	0.34
Cement	800	1.5555	11.20	0.720
Ferrite	200	0.8967	9.20	1.03
Coal	180	1.0022	33.47	3.34
Amphibole	1000	1.0283	16.04	1.56
Black mica	1000	1.1005	25.75	2.34
Kaolin	800	0.1414	19.94	14.1
Talc	1000	0.2003	14.40	7.19
Bentonite	800	0.1135	18.61	16.4
Manganese ore	750	0.2313	24.29	10.5

(3) Moisture vaporization - Coulometric titration

Reagents used: Aquamicon AX (or AS)

150ml

Aquamicon CXU

10ml

Substance	Heating Temperature (°C)	Sample Quantity(g)	Measurement Value(µg)	Moisture Content (%)
Black mica	1000	0.0733	1716	2.34
Amphibole	1000	0.2167	3391	1.56
Rocks	700	0.1176	6331	5.38
Silica	900	0.0476	2333	4.90
Casting sand	110	1.5238	1515	994ppm
"	900	1.1927	6688	0.561
Clay	110	0.0520	2048	3.94
Soil	180	0.0736	3747	5.09
Talc	200	0.4579	843	0.184
"	900	0.1871	9512	5.08
Sintered ore	750	0.0985	65	660ppm
Manganese ore	110	0.1700	833	0.490
"	750	0.0185	1922	10.4
Iron ore	750	0.1115	2653	2.38
Powdered quartz	200	1.1064	564	510ppm
"	900	0.8052	937	0.116

2. Natural Products**Key Points**

Natural products vary widely and the appropriate Karl Fischer titration should be selected to suit the particular sample. Direct titration is used for substances that dissolve in dehydrated solvent or that are unstable when heated. If the sample is stable when heated, use the moisture vaporization method. The heating temperature must be considered carefully when using that method. If the temperature is too high the breakdown of the substance could lead to interference. (For example, the end point may not be reached, or the analytical results that are obtained may be abnormally high.)

Karl Fischer titration can be carried out using either volumetric or coulometric methods, but volumetric titration is probably more suitable since natural products tend to have a high moisture content.

[Examples of Measurement]**(1) Volumetric titration**

Reagents used: Karl Fischer Reagent SS-Z (or SS)

Dehydrated Solvent GEX, KTX, SU (or MS, CM, FM) 25-50ml

Substance	Dehydrated solvents	Sample Quantity(g)	Measurement Value(mg)	Moisture Content (%)
Silver fir leaves	General-use	0.0462	3.12	6.76
Tree roots	"	0.0279	2.53	9.07
Pollen	Sugar-type	0.0071	0.64	9.0
Pine resin	Ketone-type	1.0106	0.74	0.073
Rosin	"	0.7388	6.15	0.832

(2) Moisture vaporization - Volumetric titration

Reagents used: Karl Fischer Reagent SS-Z (or SS)

Dehydrated Solvent GEX (or MS) + PG (3:1) 50-100ml

Substance	Heating Temperature (°C)	Sample Quantity(g)	Measurement Value(mg)	Moisture Content (%)
Pine resin	130	1.6708	0.83	0.050

(3) Coulometric titration

Reagents used: Aquamicon AX (or AS) 100ml
 Aquamicon CXU 5ml

Substance	Sample Quantity(g)	Measurement Value(μ g)	Moisture Content (%)
Raw lacquer	0.0247	3466	14.0
Processed lacquer	0.1211	3810	3.15

Chapter IV: List of Karl Fischer Reagents**(4) Moisture vaporization - Coulometric titration**

Reagents used: Aquamicon AX (or AS) 150ml
 Aquamicon CXU 10ml

Substance	Heating Temperature ($^{\circ}$ C)	Sample Quantity(g)	Measurement Value(μ g)	Moisture Content (%)
Silver fir leaves	130	0.0541	3800	7.02
Tree roots	100	0.0189	1723	9.12

Volumetric Titration Reagents

The requirements for volumetric titration are a Karl Fischer reagent, standard water-methanol to assess the titer and a dehydrated solvent in which to dissolve or disperse the sample.

Mitsubishi Chemical Corporation has an extensive range of reagents suitable for all levels of moisture content. Choose the combination of products that is most suitable for your particular purpose.

Karl Fischer Reagent SS Series (Pyridine-Type)

The SS Series has enjoyed an excellent reputation for quality and performance for many years.

Product	Standard	Packaging	Uses
Karl Fischer Reagent SS (Mitsubishi)	Titer 2.5-3.5mg/ml	500ml glass bottles	General-use This titration preparation can be used for a wide range of purposes.
	Titer 8-12mg/ml	500ml glass bottles	High moisture content This product allows quick, accurate measurement of moisture content over about 40% in foodstuffs, cosmetics, etc.
	Titer 0.7-1.2mg/ml	500ml glass bottles	Low moisture content This product is suitable for measuring moisture content below 100ppm in organic solvents, electrical insulating oils, gases, etc.
Dehydrated Solvent MS	Moisture content 0.2mgmg/ml or lower	500ml glass bottles	General-use (*recommended product) Suitable for organic solvents, inorganic chemicals, agricultural chemicals, pharmaceuticals, fertilizers, detergents, foodstuffs, etc.
Dehydrated Solvent ML	Moisture content 0.2mg/ml or lower	500ml glass bottles	General-use Suitable for organic solvents, inorganic chemicals, agricultural chemicals, pharmaceuticals, fertilizers, detergents, foodstuffs, etc.

Product	Standard	Packaging	Uses
Dehydrated Solvent CM	Moisture content 0.3mg/ml or lower	500ml glass bottles	Oil-type Suitable for naphtha, gasoline, diesel oil, heavy oil, electrical insulating oil, oils and fats (hardened oil, margarine, etc.), etc.
Dehydrated Solvent CP	Moisture content 0.5mg/ml or lower	500ml glass bottles	Ketone-type (*recommended product) For ketones, silicon oils, acetic acid and other lower carboxylic acids, aldehydes (except acetaldehydes), anilines, etc.
Dehydrated Solvent PE	Moisture content 0.2mg/ml or lower	500ml glass bottles	Ketone-type For ketones, silicon oils, acetic acid and other lower carboxylic acids, aldehydes (except acetaldehydes), anilines, etc.
Dehydrated Solvent FM	Moisture content 0.2mg/ml or lower	500ml glass bottles	Sugar-type Sugars, proteins, gelatine, additives, animal feeds, etc.
Dehydrated Solvent ME	Moisture content 0.2mg/ml or lower	500ml glass bottles	For gaseous samples Nitrogen, etc.

Mix Dehydrated Solvent MS with propylene glycol (PG) in a 3:1 ratio (e.g. MS90ml: PG30ml) when using a moisture vaporization system.

Standard Reagents for Titer Assessment

Mitsubishi Chemical Corporation supplies a standard watermethanol products that include a known amount of water. This products are used to assess the titer.

Select the product according to the titer of the Karl Fischer reagent that you are using. This standard reagent is also convenient for use in back titration.

Product	Standard	Packaging	Uses
Standard Water Methanol (Mitsubishi)	Moisture content: 2.0 ± 0.04mg/ml	250ml glass bottles	Used to assess titer of Karl Fischer reagents(3-10mgH ₂ O/ml)

Karl Fischer Reagent SS-Z Series (Pyridine/Chloroform-Free Type)

Mitsubishi's SS-Z range of titration products is free of both pyridine and chloroform.

These products are kind to both people and the environment.

Karl Fischer Reagent SS-Z is a volumetric titration reagent that contains neither chloroform nor methyl cellosolve. It is also free of pyridine so there is almost no odor.

A low-toxicity solvent system has been used to develop a product that is kind to both people and the environment while providing the same performance as earlier products.

These products can be used with existing moisture content measuring systems. Combine them with the dehydrated solvent that is appropriate for the sample.

Product	Standard	Packaging	Uses
Karl Fischer Reagent SS-Z (Mitsubishi)	Titer 4.5-5.5mg/ml	500ml, 1L glass bottles	General-use This titration preparation can be used for a wide range of purposes.
	Titer 0.7-1.2mg/ml	500ml glass bottles	Low moisture content This titration preparation is suitable for samples with low moisture content.
Dehydrated Solvent GEX	Moisture content: 0.2mg/ml or lower	500ml glass bottles	General-use Suitable for organic solvents, inorganic chemicals, agricultural chemicals, pharmaceuticals, fertilizers, detergents, foodstuffs, etc.
Dehydrated Solvent OLX	Moisture content: 0.5mg/ml or lower	500ml glass bottles	Oil-type Suitable for naphtha, gasoline, heavy oil, electrical insulating oil, oils, etc.
Dehydrated Solvent OL II	Moisture content: 0.3mg/ml or lower	500ml glass bottles	Oil-type (*includes chloroform) Suitable for naphtha, gasoline, heavy oil, electrical insulating oil, oils and fats, etc.

Product	Standard	Packaging	Uses
Dehydrated Solvent KTX	Moisture content: 0.5mg/ml or lower	500ml glass bottles	Ketone-type For ketones, silicon oils, acetic acid and other lower carboxylic acids, aldehydes (except acetaldehydes), etc.
Dehydrated Solvent SU	Moisture content: 0.2mg/ml or lower	500ml glass bottles	Sugar-type Sugars, proteins, gelatine, additives, animal feeds, etc.

Mix Dehydrated Solvent GEX with propylene glycol (PG) in a 3:1 ratio (e.g. GEX90ml:PG30ml) when using a moisture vaporization system.

Coulometric Titration Reagents

Coulometric titration reagents consist of anolytes which are placed in the anode chamber and catholytes which are placed in the cathode chamber. These products have a worldwide reputation for excellent performance and can be used in all manufacturers' coulometric titration systems. A general-use product and a ketone-type product (for ketones, lower carboxylic acids, silicon oils, etc.) are available. These products can be used with Aquamicon CXU catholyte. These products are kind to both people and the environment. They contain no carbon tetrachloride, methyl cellosolve, pyridine or chloroform.

Aquamicon Series

Product	Standard	Packaging	Uses
Aquamicon AX (anolyte)	Moisture content: 0.15mg/ml or lower	500ml glass bottles	General-use Used with organic solvents, inorganic chemicals, petroleum products, gases, and a wide range of other substances.
Aquamicon CXU (catholyte)	Moisture content: 0.6mg/ml or lower	5ml ampoules/10 per case	
Aquamicon AXI (anolyte)	Moisture content: 0.15mg/ml or lower	500ml glass bottles	
Aquamicon CXU (catholyte)	Moisture content: 0.6mg/ml or lower	5ml ampoules/10 per case	
Aquamicon AKX (anolyte)	Moisture content: 0.15mg/ml or lower	500ml glass bottles	Ketone-use Ketones, silicon oils, lower carboxylic acids, etc.
Aquamicon CXU (catholyte)	Moisture content: 0.6mg/ml or lower	5ml ampoules/10 per case	
Aquamicon AS (anolyte)	Moisture content: 0.15mg/ml or lower	500ml glass bottles	For Oils Naphtha, Gasolone, Diesel oil, Electrical insulation oil, etc.
Aquamicon CXU (catholyte)	Moisture content: 0.6mg/ml or lower	5ml ampoules/10 per case	

Single-Solution Coulometric Titration Reagent

Aquamicon FLS is a single-solution coulometric titration reagent. It should be used in single-solution electrolytic cells without diaphragm.

Use this product in combination with single-solution electrolytic cells.

This product is kind to both people and the environment. It contains no carbon tetrachloride, methyl cellosolve, pyridine or chloroform.

Product	Standard	Packaging	Uses
Aquamicon AXI	Moisture content: 0.15mg/ml or lower	500ml glass bottles	Used for moisture vaporization method. Organic solvents.
Aquamicon FLS			

Using Single-Solution Karl Fischer Titration

As the single-solution coulometric titration version of Karl Fischer titration has not been adopted as an official method (JIS, etc.), it should be regarded only as a convenient methodology. (It may not be possible to use this product in some types of equipment.)

Aquamicon Solid Water Standard

Product	Standard	Packaging	Uses
Aquamicon Solid Water Standard	Moisture content: 3.83±0.05%(mass percent)	10g glass bottles	For evaluation a moisture meter with a water vaporizer.

Aquamicon Standard Solution

Mitsubishi Chemical Corporation has traditionally supplied standard water/methanol as a standard reagent for assessing titer. Recently we have begun to sell a new product which has been developed in response to growing awareness of the importance of day-to-day management needs. It also reflects the demand for products that are easy to use and manage. This product is the result of long years of experience in the fields of production technology and moisture measurement technology. For added peace of mind, it is also environmentally friendly thanks to the use of lowodor, low-toxicity solvents.

Product	Titer	Packaging	Uses
Aquamicon water Standard 0.1mg	0.1mg/g	5ml ampoules/10 per case	Used to check the accuracy of coulometric titration systems.
Aquamicon water Standard 0.2mg	0.2mg/g	5ml ampoules/10 per case	Used to check the accuracy of coulometric titration systems.
Aquamicon water Standard 1mg	1mg/g	5ml ampoules/10 per case	Used to check the accuracy of coulometric titration systems.
Aquamicon water Standard 10mg	10mg/g	8ml ampoules/10 per case	Used to assess the titer of KF reagents used in automatic volumetric titration systems.

Mitsubishi Check Solution P

This end-point adjustment solution can be used with both general-use and ketone-type products. It can also be used for day-to-day management of coulometric moisture measurement systems.

Product	Moisture Content	Packaging	Uses
Check Solution P (Mitsubishi)	3.8~4.2mg/ml	100ml glass bottles with septum caps	Used when the presence of free iodine in the anolyte has caused reddishbrown discoloration. Add a suitable amount to restore a water surplus. Normally a 100µl microsyringe is used. The readiness of a coulometric moisture measurement system for normal use can be checked periodically by measuring a specific volume of Check Solution (e.g. 100µl).

ChapterV: Summary of Selection Procedures for Karl Fischer Reagents

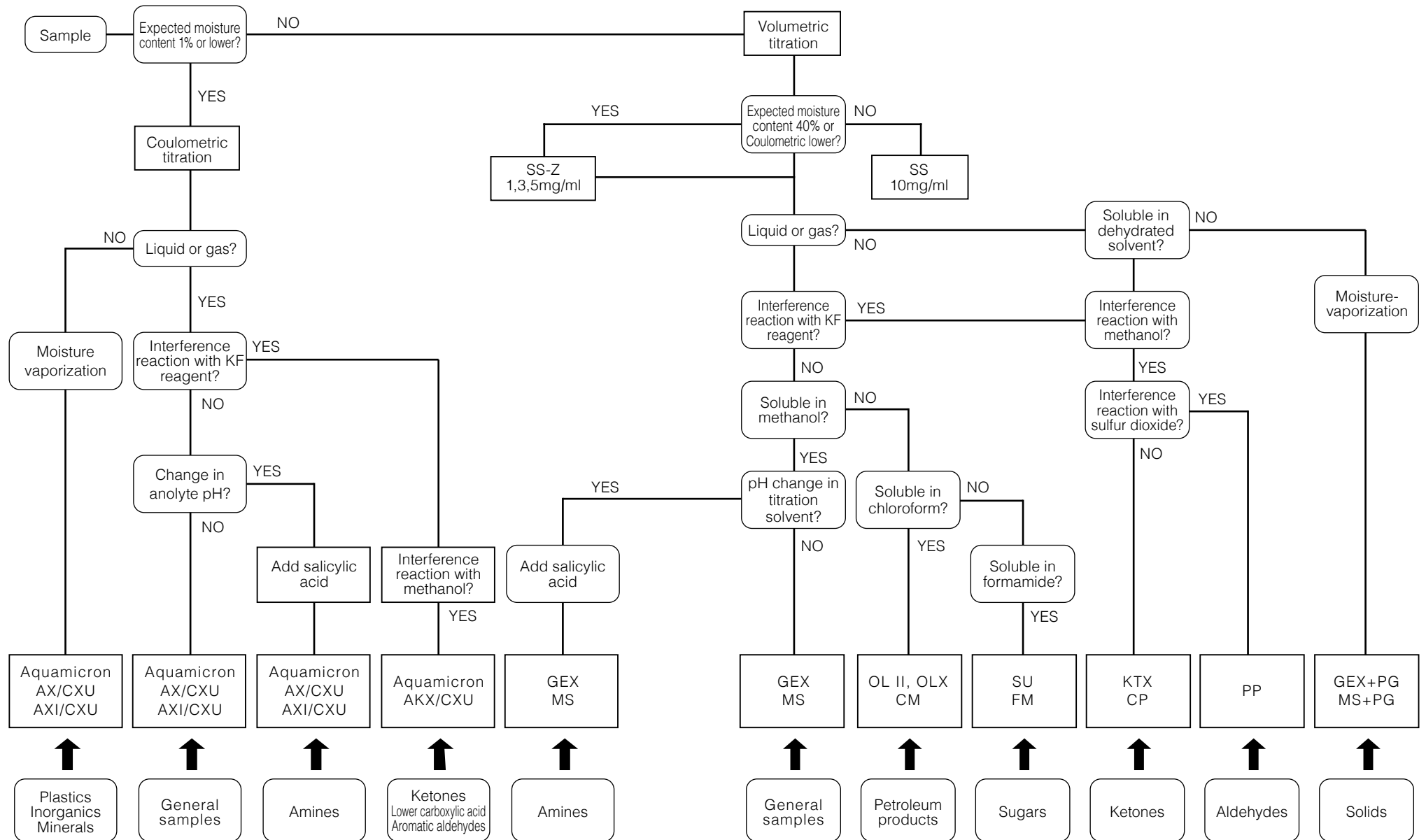

Chapter VI: Index

A :

Abietic acid -----	95
Absorbent cotton1-----	53
ABS resin -----	154,155
Acetaldehyde-----	92
Acetamide-----	106,107
Acetanilide -----	106
Acetic acid -----	95,96,97
Acetic anhydride-----	111
Acetone -----	90,107
Acetone cyanhydrin-----	107,109
Acetone oxime -----	109
Acetonitrile -----	107,108
Acetophenone-----	89,90
Acetylaceton-----	89,90
Acetylene -----	29
Acetyl peroxide -----	113
Acetyl thiourea -----	114,117
Acetylurea -----	106
Acrolein cyanohydrin acetate -----	107
Acrylic acid-----	95
Acrylic fiber -----	159
Acrylonitrile-----	107,108
Actuation oil1 -----	46
Adenosine 5'-triphosphate disodium-	187
Adhesive -----	165,167
Adipic acid -----	95,96
Adiponitrile -----	107
Aerosol -----	146
Air filter oil -----	150
(L-)Alanine -----	187
Albumin -----	189,190
Alizarin-----	89
Alkyl alcohol -----	82
Alkylbenzene1 -----	45,152
Alkyl benzene sulfonate -----	168
Alkyl diphenyl ethane-----	151
Alkyl naphthalene -----	151
Alloxan-----	100,106
Aluminum chloride -----	127,128,139
Aluminum fluoride -----	129
Aluminum nitrate-----	134,139
Aluminum oxide-----	126
Aluminum paste-----	120
Aluminum powder -----	161
Aluminum sulfate -----	132,139
Amino acid -----	186
Aminoacetonitrile -----	107
(p-)Aminoazobenzene -----	106
(ε-)Aminocapronitrile -----	107
(5-)Amino-2-chlorotoluene-4- sulfonate(C-acid) -----	160
(2-)Aminonaphthalene-1-sulfonic acid -----	160,161
(m-)Aminophenol -----	86,103,105,159,160
Aminophylline-----	189
(2-)Amino-3-picoline-----	105
(2-)Aminopyridine -----	103
Ammonia-----	40
Ammonium acetate -----	99,100
Ammonium chloride -----	127,139,140
Ammonium citrate-----	99
Ammonium nitrate-----	133,139,140
Ammonium oxalate-----	99
Ammonium phosphate-----	139
Ammonium sulfate -----	139,140
Amphibole-----	193,194
(n-)Amyl alcohol-----	83
Aniline -----	103,104,105,159,160
(2-)Anilinoethanol-----	105
Anisic acid-----	95
Anisidine (p-anisidine) --	103,105,159,160
Anthracene-----	78
Anthranilic acid-----	160,161
Antibiotics -----	189
Antimony oxide-----	126,161
Antioxidant -----	149,156,157
Apple powder -----	178
Argon -----	136
Arsenic trioxide-----	40
Aryl formate -----	97
Ascorbic acid-----	40
Asparagine-----	96,100
Aspartame-----	174,176
Aspartic acid-----	96
Asphalt -----	150
Aspirin aluminum -----	189,190
Aviation oil -----	150,152

B :

Bakelite paper ----- 158
 Barium acetate ----- 99
 Barium carbonate ----- 130,161,162
 Barium chloride ----- 127,128
 Barium fluoride ----- 129
 Barium hydroxide ----- 124
 Barium peroxide ----- 40
 Basic magnesium carbonate ----- 130
 Beer yeast ----- 184,185
 Beet ----- 185
 Bentonite ----- 193
 Benzal-n-butylimine ----- 109
 Benzaldehyde ----- 94
 Benzamide ----- 106
 Benzene ----- 78,79
 Benzenesulfonic acid ----- 96
 Benzidine yellow ----- 164
 Benzoic acid ----- 95
 Benzoic anhydride ----- 111
 Benzoin ----- 89
 Benzophenone ----- 89
 Benzothiazole ----- 103,114
 Benzothiophene ----- 114,115
 Benzotriazole ----- 109
 Benzoyl chloride ----- 111
 Benzoyl hydrazine ----- 102
 Benzyl alcohol ----- 82,83
 Benzylamine ----- 102,103,105
 Benzyl benzoate ----- 98
 Benzyl mercaptan ----- 116
 (4-) Benzyl piperidine ----- 105
 Berberine chloride ----- 189,190
 Bile acid ----- 191
 Biscuit ----- 181
 Bismuth oxide ----- 126
 Biuret ----- 106
 Blood serum ----- 191
 Boric acid ----- 40
 Borneol ----- 83
 Boron oxide ----- 40
 Brain ----- 191
 Brake oil ----- 150,152
 Brass ----- 120
 Bromobenzene ----- 81
 Bromoform ----- 81
 (1-) Bromohexadecane ----- 81

Bromonaphthalene ----- 81
 (1-) Bromotetradecane ----- 81
 Brown coal ----- 147,148
 Brucine ----- 100
 Brucine sulfate ----- 100
 Bryeslin powder ----- 142
 Bufferin ----- 190
 Butadiene ----- 78,147
 Butane ----- 78,144
 (1,4-) Butanediol ----- 82
 (iso-)Butanol ----- 82,83
 (n-) Butanol ----- 82,83
 (tert-) Butanol ----- 82,83
 (1,4-) Butenediol ----- 82
 Butter ----- 182,183
 (n-) Butyl acetate ----- 98
 Butyl aldoxime ----- 109
 (n-) Butylamine ----- 103,104,105
 (p-tert-) Butyl catechol ----- 87
 (n-) Butyl disulfide ----- 114
 (2,3-) Butylene diacetate ----- 97
 Butyl mercaptan ----- 116
 Butyl nitrite ----- 97
 Butyl rubber ----- 156
 (n-) Butyl sulfide ----- 114
 (n-) Butyl thiocyanate ----- 114
 (n-) Butyl vinyl ether ----- 84
 (n-) Butyraldehyde ----- 90
 Butyric anhydride ----- 111
 (γ-) Butyrolactam ----- 84,85,98
 (γ-) Butyrolactone ----- 98
 Butyryl chloride ----- 111

C :

C-acid ----- 160
 Cadmium (powdered metal) ----- 120
 Cadmium acetate ----- 99,100
 Cadmium chloride ----- 127
 Cadmium oxide ----- 126
 Caffeine ----- 27
 Calcium carbonate ----- 129,130,131
 Calcium chloride ----- 127
 Calcium citrate ----- 176
 Calcium fluoride ----- 127
 Calcium hydroxide ----- 125
 Calcium lactate ----- 99,100,174,175
 Calcium malonate ----- 99
 Calcium oxide ----- 126

Calcium propionate ----- 99
 Calcium stearate ----- 100
 Calcium sulfate ----- 131,130
 Camphoric acid ----- 95
 Camphor ----- 89
 Candy ----- 180,181
 Capacitor ----- 171,172
 Caproic acid ----- 95
 (ε-) Caprolactam ----- 109,110
 Caproyl chloride ----- 111
 Capryl chloride ----- 111
 Capsule ----- 190,191
 Captan ----- 141,142
 Caramel ----- 180,181
 Carbazole ----- 103
 Carbetapeten citrate ----- 189
 Carbon black ----- 156,157
 Carbon disulfide ----- 114,115
 Carbon tetrachloride ----- 81
 Carbonyl J-acid ----- 160
 Catechol ----- 87
 Cellite ----- 143
 Cellotape ----- 159
 Cellulose ----- 159
 Cement ----- 142,143,193
 Ceramics ----- 142,143
 Cereals ----- 177
 Cerium iodide ----- 127
 Cesium iodide ----- 23
 Cheese ----- 175,182,183
 Chemical fiber ----- 159
 Chemical fertilizer ----- 140
 Chewing gum ----- 181
 Chloral ----- 92,94
 Chloral hydrate ----- 92,94,100,101
 Chlorella ----- 193
 Chlorine ----- 80
 (p-) Chloroaniline ----- 105,159,160
 Chlorobenzene ----- 81
 (p-) Chlorobenzene sulfonyl chloride ----- 112
 Chlorobutanol ----- 186
 Chloroform ----- 81
 Chloronaphthalene ----- 81
 Chloropicrin ----- 141
 Chloroprene rubber ----- 156
 (6-) Chloropropylene ----- 81
 Chocolate ----- 181

Cholesterol ----- 82
 Chrome yellow ----- 161
 Chromium nitrate ----- 133
 Cinnamic acid ----- 95
 Cinnamon ----- 191
 Citric acid ----- 96,173
 Citronellol ----- 82
 Clay ----- 193,194
 Cleanser ----- 168,169
 Coal ----- 147,148,193
 Coal tar ----- 147,148
 Cobalt acetate ----- 99
 Cobalt alloy ----- 120
 Cobalt chloride ----- 128
 Cobalt nitrate ----- 133
 Cocoa ----- 184,185
 Coffee ----- 184,185
 Coke ----- 148
 Compressor oil ----- 150
 Condiment ----- 174,176,179
 Confectionery ----- 180
 Copper (II) chloride ----- 127
 Copper (I) oxide ----- 125,126
 Copper (II) oxide ----- 126
 Copper phthalophenone yellow ----- 164
 Copper sulfate ----- 131
 Copper wire ----- 120
 Copy paper ----- 159
 Corn starch ----- 178
 Cosmetics ----- 169
 Cream ----- 169,170
 Creatine ----- 96,100
 (p-) Cresidine ----- 159
 (m-) Cresol ----- 87
 (o-) Cresol ----- 87
 (p-) Cresol ----- 87
 Crotonaldehyde ----- 92
 Crude drug ----- 191
 Crude oil ----- 150,152
 Cuprous oxide ----- 162
 Curry roux ----- 184,185
 Cutting oil ----- 150,152
 Cyanamide ----- 109
 Cyanuric acid ----- 100,109
 Cylinder oil ----- 144,145
 Cyclodextrin ----- 187
 Cyclohexane ----- 78,79
 Cyclohexane carboxylic acid ----- 95

Cyclohexano----- 82
 Cyclohexanone -----89,90
 Cyclohexanone oxime-----109
 Cyclohexene ----- 78,79
 Cyclohexyl acetate----- 97
 Cyclohexyl acetic acid ----- 95
 Cyclohexylamine -----105
 Cyclopentane----- 78
 Cyclopentanone ----- 90
 (L-) Cystine -----187

D :

(n-) Decane----- 78,79
 Decanol ----- 82
 Decalin ----- 78
 (1-) Decene----- 79
 Deoxybenzoin ----- 89
 Detergent ----- 167,169
 Dextran -----187
 Dextrose -----100
 Diacetone alcohol -----89,90
 (1,3-) Diaminopropane -----105
 Di-ammonium hydrogenphosphate ----134
 Diazoaminobenzene-----109
 Dichloroacetic acid -----95,96,97
 (2,4-) Dichlorophenoxy acetic acid ----- 95
 (1,4-) Dichloro-2-butene ----- 81
 (1,2-) Dichloroethane ----- 81
 (p-) Dichloronitrobenzene ----- 110
 Dicyanamides -----109
 Dicyclohexylamine -----103
 Diesel oil ----- 149,150,152
 Diesel engine oil ----- 151
 Diethanolamine ----- 103,104,105
 Diethylamine ----- 103,104,105
 (2-) Diethylaminoethanol-----105
 Diethyl peroxide----- 113
 (N,N-) Diethylaniline -----105
 Diethylene glycol ----- 82,84
 Diethylene glycol ethyl ether ----- 85
 Diethylene glycol monoethyl ether ----- 85
 Diethyl ether----- 83
 Diglycolic acid----- 96
 Dihydropyran ----- 85
 (2,3-) Dihydrofuran ----- 84,85
 (α,α -) Dihydroxyadipic acid ----- 96
 Di-isopropylamine----- 104,105
 Di-isobutylamine-----103

Di-isopropanolamine -----103
 Di-isopropyl ketone -----38,89
 Di-isopropyl malonate----- 98
 (N,N-) Dimethyl acetamide-----107
 Dimethyl aminomethyl phenol-----105
 (3-) Dimethylamino propionitrile -----105
 (N,N-) Dimethylaniline -----103
 (N,N-) Dimethyl benzylamine----- 104,105
 (N,N-) Dimethylcyclohexylamine -----103
 (N,N-) Dimethylethanolamine -----103
 Dimethyl ether ----- 84
 (N,N-) Dimethyl formamide ----- 106,107
 Dimethylglyoxime-----109
 (2,4-) Dimethyl pentane----- 78
 (2,4-) Dimethyl-3-pentanol----- 82
 (N,N-) Dimethyl-p-toluidine -----105
 Dimethyl sulfoxide-----114,115
 Di-n-butylamine-----105
 (m-) Dinitrobenze ----- 109,110
 (3,5-) Dinitrobenzoic acid -----95,109
 Dinitrophenyl hydrazine-----108
 (2,4-) Dinitrotoluene-----110
 Dioxane -----84,85
 Dipentene----- 78
 Dipentylamine -----103
 Diphenyl----- 78
 Diphenyl carbinol----- 83
 Diphenyl ether ----- 84
 Diphenylamine ----- 103,160,161
 (1,3-) Diphenyl thiourea ----- 117
 Di-sec-butylamine-----103
 Di-tert-butyl peroxide-----113
 Dithio acid -----114,117
 (n-) Dodecane----- 79
 Dodecanol----- 82
 Dried vegetable1 ----- 77
 Drops -----181
 Dyestuff -----159

E :

Egg yolk ----- 184
 Electric insulating oil----- 149,152
 Emulsifier -----174
 Emulsion ----- 169,170
 Enamel -----162,163
 Engine oil ----- 151,152
 Enzyme----- 186
 Epoxy resin-----154,155

Erucamide----- 107
 Ethanol ----- 82,83
 Ethanolamine ----- 103
 Ethyl acetate -----97,98
 Ethylamine----- 103
 (N-) Ethyl aniline ----- 104
 Ethyl benzene ----- 78
 (p-) Ethylbenzene sulfonyl chloride---- 112
 Ethyl carbamate----- 98
 Ethyl carbonate -----97
 Ethyl chlorocarbonate-----97
 Ethyl citrate-----97
 Ethylene----- 78,147
 Ethylene bromide-----81
 Ethylene chloride -----81
 Ethylene glycol ----- 82,83
 Ethylene glycol dimethyl ether ----- 84
 Ethylene glycol monoethyl ether ---- 83,85
 Ethylene oxide----- 84
 Ethylene propylene rubber-----156
 Ethylene thiocyanate-----114
 Ethyleneurea -----106
 Ethylene vinyl acetate1 ----- 48
 Ethylene vinyl acetate copolymer
 ----- 154,155
 Ethyl formate -----97
 (2-) Ethyl hexanol ----- 83
 Ethylidene bromide -----81
 Ethyl iodode-----81
 Ethyl isothiocyanate ----- 114
 Ethyl malonate-----97
 Ethyl mercaptan----- 116
 (N-) Ethyl morpholine ----- 104
 Ethyl thioacetate ----- 114
 Ethyl thiocyanate----- 114
 Ethyl vinyl ether ----- 84
 Eugenol -----87

F :

Fat1 ----- 82
 Ferrite -----120,193
 Fertilizer ----- 139
 Fiber----- 158
 Filter paper ----- 158
 Flavoring ----- 173,174
 Fluorine glass----- 143
 Fluorine resin ----- 155

Formaldehyde-----92
 Formaldehyde cyanhydrine----- 107,109
 Formalin----- 82
 Formamide -----106,107
 Formic acid-----95,97
 Furfural ----- 89

G :

Gadolinium oxide----- 126
 Gasoline-----150,152
 Gasoline engine oil----- 151,152
 Gear oil ----- 151,152
 Gelatin ----- 184,185,191
 Geraniol -----82
 Gibberellin methyl ester----- 189
 Glass powder-----142,143
 Glass wool----- 143
 Glucose -----179
 Glutamic acid-----96
 Glutathione -----189,190
 Glycerine-----82,83
 Glycine -----96
 Glycolic acid-----96
 Glycylglycine ----- 187
 Granulated sugar ----- 179
 Grease----- 149,151
 Grinding oil -----150,152
 Guaiacol ----- 87
 Guanidine nitrate ----- 109
 Gypsum ----- 132

H :

Hair (black,blond) ----- 191
 Hair tonic----- 169,170
 Heat treatment oil----- 150
 Heavy oil -----150,152
 Helium ----- 29
 Hemin----- 189
 Hepta-aldoxime ----- 103
 (n-) Heptane----- 26
 Heptyl mercaptan ----- 116
 Hexadecyl bromide ----- 82
 Hexamethyl benzene ----- 78
 (n-) Hexane----- 79
 (1-) Hexene ----- 79
 (n-) Hexylamine ----- 103,105
 Hexyl mercaptan ----- 116
 High-grade chemical fertilizer ----- 140

(L-) Histidine	100
Hop	185
Hydraulic oil	150,151
Hydrazine hydrate	101
Hydrazine hydrochloride	108
Hydrochloric acid	122
Hydrocyanic acid	122
Hydrofluoric acid	122
Hydrogen	135,136
Hydrogen chloride gas	122
Hydrogen peroxide	40
Hydrogen sulfide	149
Hydroquinone	86
(α -) Hydroxyadipic acid	96
Hydroxylamine	40
(α -) Hydroxybutyric acid	96
(δ -) Hydroxycaproic acid	96
(1-) Hydroxy-2-naphthoic acid	160

I:

Imidazole	103
Iminodiacetic acid	96
Indole	103
Ink	164
Insecticide	141
Iodobenzene	81
Iodoform	81
Iron (III) chloride	127
Iron (III) oxide	126
Iron ore	192,193,194
Isoamyl acetate	98
Isoamyl alcohol	82
Isoamyl mercaptan	116
Isobutyraldehyde	92
Isoctane	78,79
Isocyanate	110
Isopropanol	82
Isopropylamine	103
Isopropyl ether	84,85
Isopropyl isovalerate	98
Isopropyl mercaptan	116

J:

J-acid	160
Juice powder	184

K:

Kaolin	193
Kerosene	149,150,152
Kitazine (-P)	141
Kraft paper	159

L:

Lacquer	163,196
Lauryl peroxide	113
Lead acetate	99
Lead dioxide	125
Lead glass	143
Leaf	195,196
Leucine	96
Libotite	189
Licorice powder	191
Ligroin	79
Limestone	193
Linolenic acid	95
Lipid	186
Liquefied petroleum gas	144,146,147
Liquid crystal	171,172
Liquid Paraffin	150,152
Lithium acetate	100
Lithium chlorate	129
Lithium chloride	128,129
Lithium citrate	99,100
Lithium hydroxide	124
Lotion	169
LPG	144,146,147
Lubricant	149,150

M:

Machine-made paper	159
Machine oil	150,152
Magnesium acetate	99,100
Magnesium carbonate	130
Magnesium chloride	127,128
Magnesium hydroxide	125
Magnesium hypophosphate	134
Magnesium oxide	125,126
Maize	178
Maleic acid	96
Malic acid	174,175,176
Malonamide	106
Malonic acid	96
Maltitol	174

Maltose	179
Malt syrup	178,179,181
Manganese benzoate	100
Manganese carbonate	130
Manganese chloride	127,128
Manganese ore	193,194
Manganese oxide	125,126
Manganese sulfate	131
(D-) Mannitol	82
Margarine	182,183
Mayonnaise	179,180
Meat extract	182,183
Medicinal wafer	191
Melamine resin	109,153,154
Mercaptan	114,149
Mercury (I) nitrate	133
Mercury (I) oxide	125
Mesitylene	78
Metaboric acid	40
Metacrylic resin	155
Metanilic acid	160
Methacrylic acid	95
Methane sulfonyl chloride	112
Methanol	82,83
Methionine	96
(2-) Methoxy-2-methyl-4-pentanone	90
(3-) Methoxypropylamine	103
Methyl acetate	97,98
Methyl acrylate	97,98
Methyl adipate	97
(2-) Methylaminopyridine	104,105
Methyl benzoate	97
(2-) Methyl-4-butanol	82
Methyl carbamate	98
Methyl carbitol	84
Methyl chloride	81,146
Methyl cyclohexane	78
Methyl cyclopentane	78
Methylene aminoacetone nitrile	107
Methylene bromide	81
Methylene chloride	81
Methylene iodide	81
Methyl ethyl ketone	89,90
Methyl formate	97
Methyl glycolate	97
(3-) Methylhexane	78
Methyl iodide	81
Methyl isobutyl ketone	89,90

Methyl isothiourea	114
Methyl methacrylate	97
(N-) Methyl morpholine	105
(2-) Methyl-1,3-propanediol	82
(N-) Methyl pyrrolidine	110
2,2-Methyl pentane	78
(5-) Methyl resorcinol	87
Methyl salicylate	97
Methyl sebacate	97
(2-) Methyl tetrahydrofuran	85
(N-) Methyl thiourea ¹	117
Methyl valerate	97
Mica	193,194
Milk	182,183
Mineral oil	151,152
Mint	191
Miso	179
Monochloroacetic acid	95,96
Monoethanolamine	105
Morpholine	103
Muscle	191

N:

Namekat	141,142
Naphtha	152
Naphthalene	78,79
Naphthalenesulfonic acid	96
(α -) Naphthol	87
(β -) Naphthol	87
Naphthoquinone	112
Naphthylamine	103
(1-) Naphthyl isocyanate	109
(1-) Naphthyl isothiocyanate	114
Natural rubber	156
Nickel	120
Nickel acetate	99
Nickel hydroxide	125
Nickel oxide	126
Ninhydrin	89,100
Nitric acid	121,122
Nitrile-butadiene rubber	156
Nitrilotriacetic acid	96
(m-) Nitroaniline	110,160
Nitroethane	110
Nitrogen	135,136
Nitroglycerine	109
Nitromethane	109,110
(o-) Nitro-p-chloroaniline	110

(p-) Nitrophenol ----- 110,160
 (1-) Nitropropane ----- 109,110
 (2-) Nitropropane ----- 109,110
 (m-) Nitro-p-toluidine ----- 110
 (N-) Nitrosodiphenylamine ----- 109
 Nucleic acid ----- 186,187
 (6-) Nylon ----- 154,155
 (6,6-) Nylon ----- 154,155

O :

Octadecane ----- 78
 Octadecanol ----- 82
 Octane ----- 78
 Oil paper ----- 159
 Oleic acid ----- 95
 Oleylamide ----- 107
 Oxalic acid ----- 96,97,100
 Oxygen ----- 135,136

P :

Paint ----- 162,163
 Palm oil ----- 183
 Pancreas ----- 191
 Pantechinan ----- 189
 Paper ----- 158,159
 Paper tape ----- 159
 Paraffin wax ----- 157
 Paste ----- 166
 Penicillin(1,3-) ----- 190
 Pentadiene ----- 78
 Pentaerythritol ----- 82
 (n-) Pentane ----- 78,79
 (2-) Pentene ----- 78
 Peri acid ----- 159
 Pharmaceuticals ----- 186,188
 (o-) Phenanthroline ----- 100
 Phenanthrene ----- 78
 (p-) Phenetidine ----- 159,160
 Phenol ----- 86,87
 Phenol resin ----- 153,154,155
 Phenyl acetate ----- 97
 Phenylalanine ----- 96
 Phenylhydrazine hydrochloride ----- 109
 Phenyl isocyanate ----- 109
 (3-) Phenylpropionaldehyde ----- 94
 (1-) Phenyl-2-thiourea ----- 117
 Phosphoric acid ----- 122
 Phosphate glass ----- 143

Phosphomycin Ca ----- 189,190
 Photocopy paper ----- 159
 Photoresist ----- 171,172
 Photosensitive resin ----- 164
 Phthalic acid ----- 96
 Phthalic anhydride ----- 111
 (2-) Picoline ----- 103
 Picric acid ----- 87
 Pigment ----- 161,162
 Pill ----- 191
 Pine resin ----- 195
 Piperazine ----- 100,103,105
 Piperidine ----- 103,104,105
 Pitch tar ----- 148
 Plastics ----- 153
 Pollen ----- 195
 Polyacetal ----- 155
 Polybutene ----- 151
 Polybutylene terephthalate(PBT) ----- 154,155
 Polycarbonate ----- 154,155
 Polyester ----- 154,159
 Polyethylene ----- 154,155
 Polyethylene terephthalate(PET) -- 154,155
 Polyglycerine ----- 168
 Polyimide ----- 154
 Polymethyl methacrylate ----- 154
 Polyol ----- 155
 Polyoxymethylene ----- 154
 Polypeptide ----- 189
 Polypropylene ----- 154,155
 Polystyrene ----- 154,155
 Polytetrafluoroethylene ----- 154
 Polyvinyl acetate ----- 153
 Polyvinyl alcohol ----- 153,154,155
 Polyvinyl butyral ----- 154,155
 Polyvinyl chloride ----- 153
 Potassium asparaginate ----- 187
 Potassium carbonate ----- 130
 Potassium chloride ----- 127,128,129,139,140
 Potassium dichloroisocyanurate ----- 112
 Potassium fluoride ----- 127
 Potassium glycyrlrhizinate ----- 174
 Potassium hydrogen tartrate ----- 99
 Potassium hydroxide ----- 124
 Potassium iodide ----- 127
 Potassium metabisulfite ----- 132
 Potassium nitrate ----- 133

Potassium oxalate ----- 99
 Potassium permanganate ----- 133
 Potassium persulfate ----- 40
 Potassium sorbate1 ----- 74,175,176
 Potassium xanthogenate ----- 189
 Potato chip ----- 181
 Power cable rubber ----- 156
 Press board paper ----- 158
 Printed circuit board ----- 172
 Propane ----- 78,144,146,147
 (1,2-) Propane diamine ----- 105
 (1,2-) Propanediol ----- 82
 (1,3-) Propanediol ----- 82
 (i-) Propanol ----- 83
 (n-) Propanol ----- 83
 Propargyl alcohol ----- 82
 Propionaldehyde ----- 92
 Propionanilide ----- 106
 Propionic acid ----- 95,96,97
 Propionic anhydride ----- 111
 Propionyl chloride ----- 111
 Propylamine ----- 103
 (n-) Propylamine ----- 103
 (i-) Propylamine ----- 105
 Propylene ----- 78
 Propylene glycol ----- 83
 Propylene oxide ----- 84,85,86
 Prussian blue ----- 161
 Pyridine ----- 103
 (2-) Pyridyl ethanol ----- 103
 (4-) Pyridyl ethanol ----- 103
 Pyrogallol ----- 87
 Pyromellitic acid ----- 100
 Pyrrole ----- 103,105
 Pyrrolidine ----- 103,105

Q :

Quartz ----- 193,194
 Quinalizarin ----- 89
 Quinoline ----- 103
 (p-) Quinone ----- 112

R :

Raffinose ----- 100
 Rapeseed oil ----- 182
 Red iron oxide ----- 126,161
 Red phosphorus ----- 120
 Refrigerating machine oil ----- 149,150,152

Resorcinol ----- 87
 (L-) Rhamnose ----- 100
 (Small) Rice cracker ----- 181
 Ricinoleic acid ----- 96
 Rinse ----- 169,170
 Rock ----- 192,193,194
 Rolling oil ----- 150,152
 Roots ----- 195,196
 Rosin ----- 195
 Rotary pump oil ----- 150
 Rubber ----- 156
 Rust preventive oil ----- 150,152
 Rutin ----- 189

S :

Saccharin ----- 175,176
 Salad oil ----- 183
 Salicylaldehyde ----- 94
 Salicylamide ----- 106
 Salicylic acid ----- 96,97
 Sand ----- 192,194
 Sarcosine ----- 96
 Sealer ----- 143
 Sebacic acid ----- 96
 Sebaconitrile ----- 107
 Semicarbazide hydrochloride ----- 109
 Sesame oil ----- 183
 Shampoo ----- 168
 Silica ----- 194
 Silicon rubber ----- 156
 Silicon oil ----- 149,151
 Silicon oxide ----- 126
 Silicon wafer ----- 172
 Silver (I) oxide ----- 125
 Snack ----- 181
 Soap ----- 167,169
 Sodium acetate ----- 99,100
 Sodium adipicate ----- 99
 Sodium arsenite ----- 133
 Sodium aspartate ----- 100,189
 Sodium benzoate ----- 99,174,175,176
 Sodium bicarbonate ----- 129,130
 Sodium carbonate ----- 130
 Sodium chloride ----- 127
 Sodium chondroitin sulfate ----- 174,176
 Sodium citrate ----- 99,100,174,175
 Sodium glutamate ----- 174,176

- Sodium 5'-guanylate----- 176
 Sodium hydroxide----- 124
 Sodium 5'-inosinate----- 174,175,176
 Sodium formate-----99
 Sodium hydrosulfite----- 132
 Sodium iodide-----128,129
 Sodium L-aspartate-----100,189
 Sodium metaarsenite----- 41
 Sodium metabisulfite----- 132
 Sodium metasilicate----- 134
 Sodium naphthionate-----99,100,160,161
 Sodium nitrate----- 133,134,140
 Sodium nitrite----- 133
 Sodium peroxide-----40
 Sodium phthalate-----99
 Sodium polyphosphate----- 176
 Sodium pyrosulfite----- 131
 Sodium succinate----- 99,176
 Sodium sulfate----- 131,132
 Sodium sulfite----- 131,132
 Sodium tartrate-----99
 Sodium tetraborate----- 133
 Sodium thiosulfate----- 41
 Sodium tripolyphosphate----- 134
 Soil-----193,194
 Sorbic acid-----174,175,176
 Sorbit-----174
 (D-) Sorbitol----- 82
 Soup-----179,180
 Soy bean oil----- 183
 Soy flour----- 178
 Soy milk----- 184
 Soy sauce----- 179,180
 Spice----- 180
 Spray----- 147
 Starch----- 177
 Stearamide----- 106
 Stearic acid----- 95,96,97,157
 Stearoyl chloride-----111
 Stearyl alcohol-----82
 Strontium chloride----- 127,128
 Styrol foam----- 155
 Styrene----- 78
 Styrene-butadiene rubber----- 156
 Succinic acid-----96
 Succinic anhydride-----111
 Sugar----- 179,180,186
 Sugar syrup----- 179
- Sulfanilic acid-----96
 Sulfur----- 120,141,157
 Sulfur dioxide----- 146
 Sulfur hexafluoride----- 128
 Sulfuric acid----- 121,122
 Surfactant----- 168
 Sweetener----- 174
 Synthetic paper----- 159
- T:**
- Talc-----193,194
 Tea----- 184
 Tartaric acid-----96
 Terpinenol-----82
 Tetrabromoethane-----81
 (1,1,2,2-) Tetrachloroethane-----81
 (1-) Tetradecene----- 79
 Tetrahydrofuran----- 84,85
 Tetramethylene oxide-----84
 Terephthalic acid-----96
 Thiamine hydrochloride-----174
 Thinner----- 163
 Thioacetic acid----- 114,117
 Thiobenzamide-----117
 Thioglycollic acid----- 116
 (2-) Thionaphthol----- 116
 Thiophene-----114
 Thiophenol----- 116
 Thiourea----- 114,116,117
 Tin (II) chloride----- 127
 Tin (IV) chloride----- 127
 Tire rubber----- 156
 Titanium----- 120
 Titanium oxide----- 126,161,162
 Toluene-----78,79
 Toluene 2,4-disulfonyl chloride-----112
 Toluenesulfonic acid-----96
 (o-) Toluenesulfonamide----- 160
 (p-) Toluene sulfonyl chloride-----112
 Toluidine----- 103,105,160
 Toner----- 164
 Toothpaste----- 191
 Transformer oil-----149,150
 Triacetone peroxide-----113
 Triazine----- 103
 Triazole----- 103
 Tri-n-butylamine-----104,105
 Trichloroacetic acid-----95
 (1,1,1-) Trichloroethane-----81
 (1,1,2-) Trichloroethane-----81
 Triethanolamine----- 103,105
 Triethylamine----- 103
 Trifluoroacetic acid-----95
 Trimethylacetic acid-----95
 Trimethylamine----- 103
 (2,2,4-) Trimethyl pentane-----78
 Tri-isopropanolamine----- 103
 Tri-n-propylamine----- 105
 Tris (hydroxymethyl) aminomethane--- 103
 Tri-sodium phosphate----- 134
 Tungsten----- 120
 Turbine oil----- 150,152
- U:**
- Undecanol-----83
 Uranyl acetate-----99
 Urea----- 106,139,140
 Urea resin----- 153,154,155
 Urethane----- 154,155
- V:**
- (n-) Valeric anhydride-----111
 Valeryl chloride-----111
 Valine-----96
 Vanadium chloride----- 128
 Varnish----- 162
 Vegetable oil----- 182
 Vinyl acetate----- 155
 Vinyl chloride-----80,81,146,155
 Vinyl ether----- 84,85
 (N-) Vinyl pyrrolidone----- 110
 Vitamin B12----- 187
 Vitamin B1 hydrochloride----- 187
 Vitamin C-----186,187
 Vulcanization accelerator-----156,157
- W:**
- Wafers----- 181
 Wasabi-----173,180
 Wax-----144,146
 Wheat----- 178
 Wheat flour----- 178
 Wool----- 159
- X:**
- Xylene-----78,79
 Xylenesulfonic acid-----96
 (2,6-) Xylenol----- 87
- Y:**
- Yeast extract-----174,176,187
- Z:**
- Zinc acetate-----99
 Zinc fluoride----- 129
 Zinc oxide----- 125,126,157
 Zinc (Powdered metal)----- 120
 Zinc stearate-----99
 Zinc sulfate----- 131

Afterword

Nine years have passed since I first thought of the production of this Karl Fischer Reagent Manual and the work was suspended for a considerable period. Now that the project is finally complete, it feels as if a heavy load has been lifted from my shoulders. I hope that this book will assist you with the use of the various Karl Fischer reagent products.

At the completion of the project, I should like to acknowledge the contribution of Mr. Shin'ichi Kuwata (formerly leader of this group) who created the basic framework for the book, Professor Kaname Muroi who has spent many years researching the Karl Fischer moisture measurement method and Mr. Mitsumasa Ono (currently with Daia Instruments Co., Ltd.) who carried out the actual Karl Fischer moisture measurements used as examples in this book. I should like also to thank Mr. Akiyoshi Nozawa (currently of Nippon Rensui Co., Ltd.), Ms. Hiroko Fujino, Ms. Akiyo Sekino (retired), Ms. Yuka Nitta (nee Fujimoto, retired) and Ms. Naoko Katayama.

Thanks are due also to Mr. Kazuo Kikuchi, Director, Business Department, Deputy General Manager Masaki Hayashi, Acting Department Manager Takazumi Kanekiyo, Acting Department Manager Toshiyuki Narikiyo, Mr. Toshihiko Yamashita, Mr. Takashi Kowada, Mr. Mitsunari Morishita and Kengo Ito of Mitsubishi Chemical Corporation's Functional Chemical Company, and to Mr. Yasuo Koike and Kazuo Kumamoto, Directors and Group Leader Toshio Kaneko of the Analytical Sciences Laboratory at the Yokohama Research Center. Without their assistance this project would not have been possible.

Hiromasa Kato (responsible for the text)
Analytical Sciences Laboratory
Yokohama Research Center

July 1999



MITSUBISHI CHEMICAL CORPORATION

Tokyo Head Office

1-1, Marunouchi 1-chome, Chiyoda-ku, Tokyo 100-8251, Japan

Telephone: +81-3-6748-7246 Facsimile: +81-3-3286-1226

Email: mcckf@cc.m-kagaku.co.jp

copyright ©2004 by Mitsubishi Chemical Corporation
All rights reserved.
Edited and published by Mitsubishi Chemical Corporation
Printed in Japan

